

DUAL WALL FABRICATED 60° REDUCING WYES
30"x4" - 30"x10" DIAMETER

PART #	PIPE SIZE	A	B	C	JOINT
3080AN60	30 x 4 in (750 x 100 mm)	41.2 in (1046 mm)	26.2 in (665 mm)	30.7 in (781 mm)	*
3080AN6065B	30 x 4 in (750 x 100 mm)	33.0 in (837 mm)	25.5 in (649 mm)	26.6 in (676 mm)	WT
3081AN60	30 x 6 in (750 x 150 mm)	41.2 in (1046 mm)	27.2 in (691 mm)	30.7 in (781 mm)	*
3081AN6065B	30 x 6 in (750 x 150 mm)	33.0 in (837 mm)	26.4 in (671 mm)	26.6 in (676 mm)	WT
3082AN60	30 x 8 in (750 x 200 mm)	45.3 in (1151 mm)	28.9 in (734 mm)	32.8 in (833 mm)	*
3082AN6065B	30 x 8 in (750 x 200 mm)	37.1 in (942 mm)	27.9 in (710 mm)	28.7 in (728 mm)	WT
3083AN60	30 x 10 in (750 x 250 mm)	49.4 in (1256 mm)	31.6 in (803 mm)	34.9 in (885 mm)	*
3083AN6065B	30 x 10 in (750 x 250 mm)	45.3 in (1151 mm)	30.3 in (771 mm)	30.7 in (781 mm)	WT

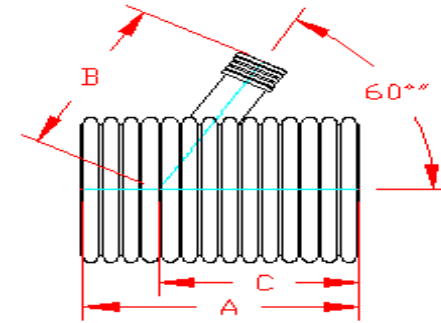

PLAIN END

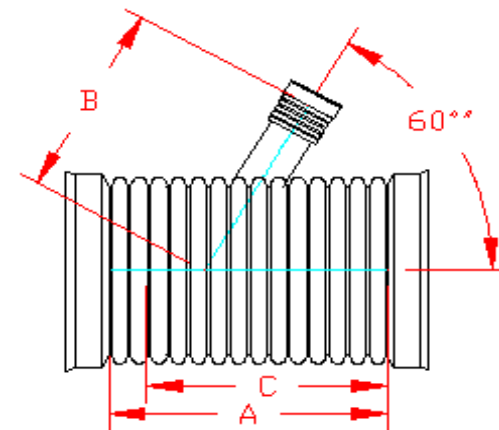

WT (INCLUDES 3 GASKETS)

* = PLAIN END
 ST = SOIL TIGHT
 WT = WATER TIGHT

NOTE: ALL FITTINGS DIMENSIONS ARE FOR REFERENCE ONLY

© 2023 Advanced Drainage Systems, Inc.



DRAWING #:	2370	
DRAWN BY:	JCB	06.14.06
APPROVED BY:	JCB	06.26.07
REVISIONS:	NJP	06.14.07