

30 __ AGS __ X

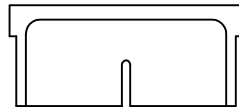

HOOD

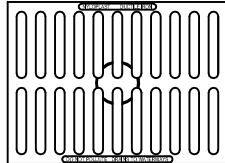

2' X 2' STANDARD GRATE

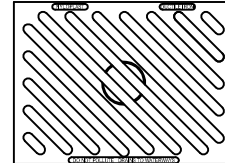

2'X2' DIAGONAL GRATE

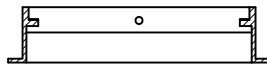

FRAME



12" BASE PLATE



15" BASE PLATE



18" BASE PLATE

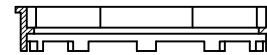

24" BASE PLATE

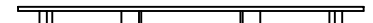

30" BASE PLATE

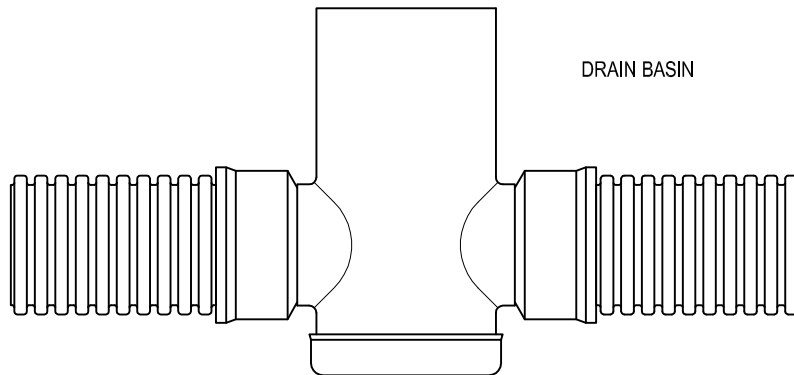

DRAIN BASIN

THIS PRINT DISCLOSES SUBJECT MATTER IN WHICH NYLOPLAST HAS PROPRIETARY RIGHTS. THE RECEIPT OR POSSESSION OF THIS PRINT DOES NOT CONFER, TRANSFER, OR LICENSE THE USE OF THE DESIGN OR TECHNICAL INFORMATION SHOWN HEREIN REPRODUCTION OF THIS PRINT OR ANY INFORMATION CONTAINED HEREIN, OR MANUFACTURE OF ANY ARTICLE HEREFROM, FOR THE DISCLOSURE TO OTHERS IS FORBIDDEN, EXCEPT BY SPECIFIC WRITTEN PERMISSION FROM NYLOPLAST.

©2013 NYLOPLAST

DRAWN BY	CJA	MATERIAL
DATE	06-21-01	
APPD BY	CCA	PROJECT NO./NAME
DATE	09-03-13	
DWG SIZE	A	SCALE 1:20 SHEET 1 OF 1

	3130 VERONA AVE BUFORD, GA 30518 PHN (770) 932-2443 FAX (770) 932-2490 www.nyloplast-us.com	
	TITLE	
2 FT X 2 FT FAMILY		
DWG NO.	7002-110-007	REV F