

DUAL WALL FABRICATED 60° REDUCING WYES
30"×12" - 30"×24" DIAMETER

PART #	PIPE SIZE	A	B	C	JOINT
3084AN60	30 x 12 in (750 x 300 mm)	53.6 in (1360 mm)	37.5 in (954 mm)	36.9 in (938 mm)	*
3084AN6065B	30 x 12 in (750 x 300 mm)	45.3 in (1151 mm)	35.6 in (905 mm)	32.8 in (833 mm)	WT
3085AN60	30 x 15 in (750 x 375 mm)	53.6 in (1360 mm)	43.6 in (1107 mm)	36.9 in (938 mm)	*
3085AN6065B	30 x 15 in (750 x 375 mm)	45.3 in (1151 mm)	41.0 in (1041 mm)	32.8 in (833 mm)	WT
3086AN60	30 x 18 in (750 x 450 mm)	57.7 in (1465 mm)	44.4 in (1127 mm)	39.0 in (990 mm)	*
3086AN6065B	30 x 18 in (750 x 450 mm)	49.4 in (1256 mm)	41.7 in (1059 mm)	34.9 in (885 mm)	WT
3087AN60	30 x 24 in (750 x 600 mm)	65.9 in (1674 mm)	48.6 in (1235 mm)	43.1 in (1094 mm)	*
3087AN6065B	30 x 24 in (750 x 600 mm)	57.7 in (1465 mm)	45.5 in (1155 mm)	39.0 in (990 mm)	WT

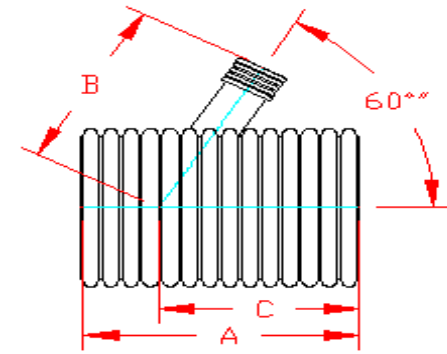

PLAIN END

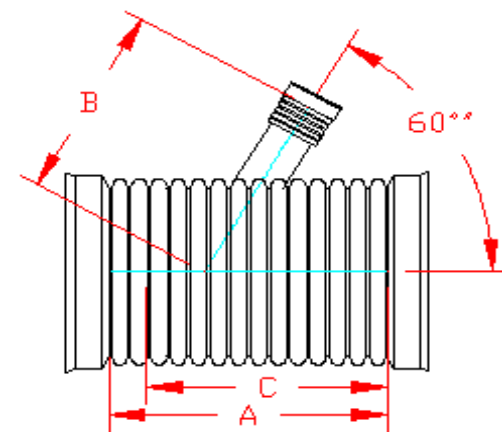

WT (INCLUDES 3 GASKETS)

* = PLAIN END
 ST = SOIL TIGHT
 WT = WATER TIGHT

NOTE: ALL FITTINGS DIMENSIONS ARE FOR REFERENCE ONLY

© 2023 Advanced Drainage Systems, Inc.



DRAWING #:	2370A	
DRAWN BY:	JCB	04.20.06
APPROVED BY:	JCB	06.26.07
REVISIONS:	NJP	06.14.07