

DUAL WALL FABRICATED 60° REDUCING WYES
42"×12" - 42"×24" DIAMETER

PART #	PIPE SIZE	A	B	C	JOINT
4284AN60	42 x 12 in (1050 x 300 mm)	62.3 in (1582 mm)	44.8 in (1138 mm)	44.9 in (1140 mm)	*
4284AN6065B	42 x 12 in (1050 x 300 mm)	51.9 in (1318 mm)	42.8 in (1087 mm)	39.7 in (1009 mm)	WT
4285AN60	42 x 15 in (1050 x 375 mm)	62.3 in (1582 mm)	50.8 in (1291 mm)	44.9 in (1140 mm)	*
4285AN6065B	42 x 15 in (1050 x 375 mm)	51.9 in (1318 mm)	48.3 in (1226 mm)	39.7 in (1009 mm)	WT
4286AN60	42 x 18 in (1050 x 450 mm)	67.5 in (1714 mm)	51.7 in (1312 mm)	47.5 in (1207 mm)	*
4286AN6065B	42 x 18 in (1050 x 450 mm)	57.1 in (1450 mm)	49.0 in (1244 mm)	42.3 in (1075 mm)	WT
4287AN60	42 x 24 in (1050 x 600 mm)	77.9 in (1977 mm)	55.9 in (1419 mm)	52.7 in (1338 mm)	*
4287AN6065B	42 x 24 in (1050 x 600 mm)	67.5 in (1714 mm)	52.7 in (1339 mm)	49.5 in (1258 mm)	WT

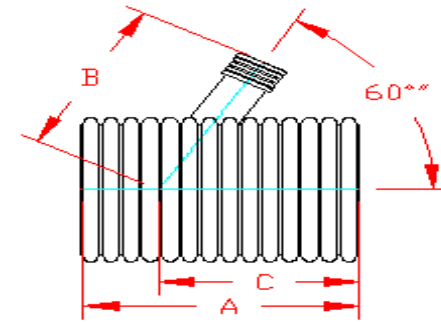

PLAIN END

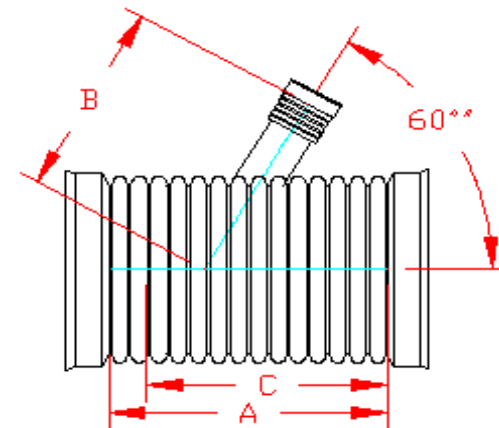

WT (INCLUDES 3 GASKETS)

* = PLAIN END
 ST = SOIL TIGHT
 WT = WATER TIGHT

NOTE: ALL FITTINGS DIMENSIONS ARE FOR REFERENCE ONLY

© 2023 Advanced Drainage Systems, Inc.



DRAWING #:	2380A	
DRAWN BY:	JCB	04.20.06
APPROVED BY:	JCB	06.26.07
REVISIONS:	NJP	06.14.07