

AQUABOX CUBE MODULE TECHNICAL SPECIFICATION

NTS

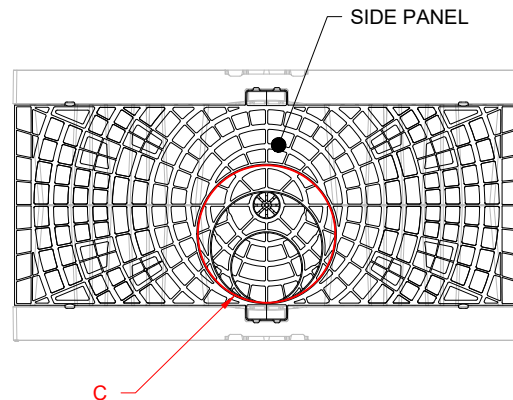
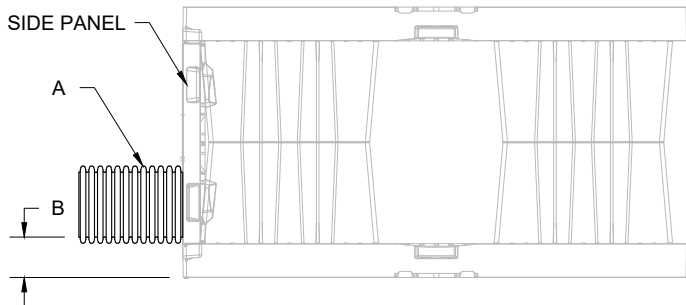
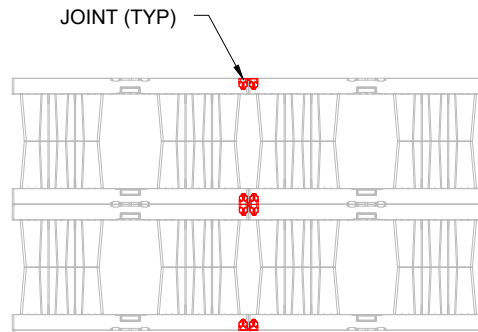
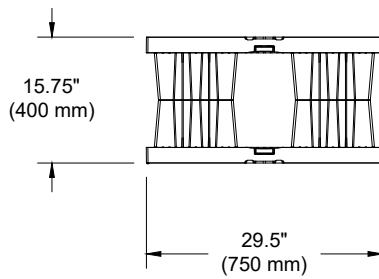
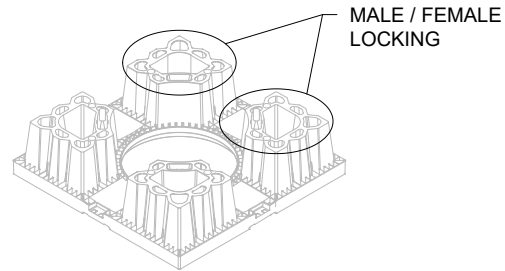
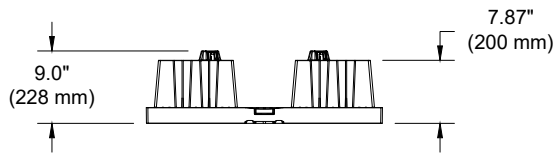
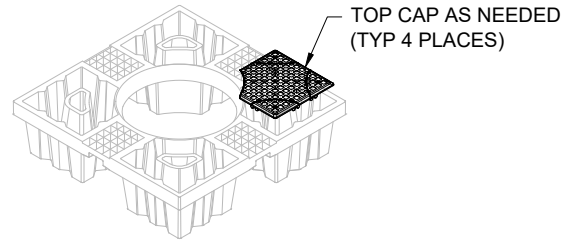
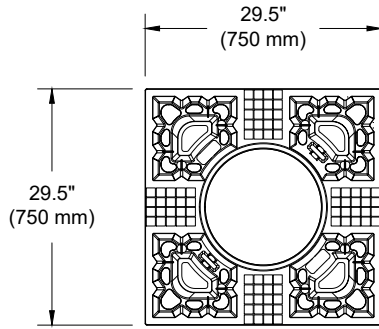

STUB CONNECTION	STUB (A)	INVERT (B)	MARKED CUT HOLE (C)
6" ADS N-12 (ECCENTRIC)	6" (150 mm)	2.5" (62 mm)	200 mm
		6" (150 mm)	

NOTE: ALL DIMENSIONS ARE NOMINAL

TECHNICAL SPECIFICATIONS
AQUABOX CUBE MODULE

DATE: 08/20/24
DRAWING #: 771-011
DRAWN: SMW
CHECKED: JLM

Aquabox
Modular Stormwater Management System

4640 TRUEMAN BLVD
HILLIARD, OH 43026

ADS

THIS DRAWING HAS BEEN PREPARED BASED ON INFORMATION PROVIDED TO ADS UNDER THE DIRECTION OF THE SITE DESIGN ENGINEER OR OTHER PROJECT REPRESENTATIVE. THE SITE DESIGN ENGINEER SHALL REVIEW THIS DRAWING PRIOR TO CONSTRUCTION. IT IS THE ULTIMATE RESPONSIBILITY OF THE SITE DESIGN ENGINEER TO ENSURE THAT THE PRODUCT(S) DEPICTED AND ALL ASSOCIATED DETAILS MEET ALL APPLICABLE LAWS, REGULATIONS, AND PROJECT REQUIREMENTS.