

Barracuda[®] Concrete

Installation Guide

Barracuda Max & Barracuda S4, S6, S8 Concrete Installation Guide

This installation guide is reference for installing the Barracuda Max S4, S6, S8 Water Quality Units into a precast concrete structure in the field.



(1) Deflector Plate



(1) Center Funnel Extender

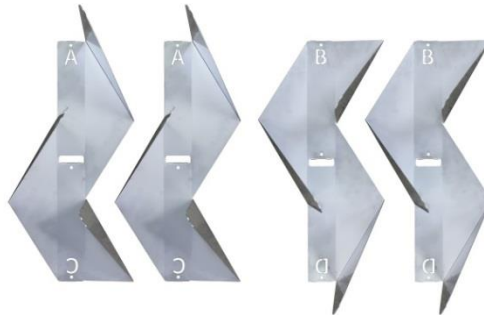









(2) A/C Stainless Steel
Tooth Set

(2) B/D Stainless Steel
Tooth Set



(1) Barracuda Max
Plastic Funnel

S4	 (4) Stainless Steel Funnel Mounting Flanges	 (1) Roll of Conseal [®]	 (16) Concrete Anchor $\frac{1}{4}$ x $2\frac{1}{4}$ "
S6	 (4) Stainless Steel Funnel Mounting Flanges	 (3) Roll of Conseal [®]	 (16) Concrete Anchor $\frac{1}{4}$ x $2\frac{1}{4}$ "
S8	 (8) Stainless Steel Funnel Mounting Flanges	 (4) Roll of Conseal [®]	 (22) Concrete Anchor $\frac{1}{4}$ x $2\frac{1}{4}$ "

Please check that all components are on site. Below is a list of tools that may be required for installation.

- 1/4" Diameter Carbide Tipped Concrete Bit
- Standard Electrical or Battery Operated Drill
- Adjustable Wrench
- Marker for writing on the concrete wall
- Hammer Drill for Concrete (Fits the 1/4" Diameter Concrete Drill Bit)
- 7/16" Driver or deep socket for installation of provided $\frac{1}{4}$ " Concrete Wedge Anchors
- Hammer
- Level
- Ladder that will extend to bottom of the structure
- Safety Glasses
- Hard Hat
- Protective Gloves
- Site Drawings
- ADS Design Layout

Installation Instructions (These directions assume the manhole base and riser have been assembled, but that the top slab/cone has not been set).

*Do not insert the inlet or outlet pipes until after the Barracuda Max internals have been installed. If pipes must be inserted in advance, the pipes should not protrude into the structure as they will interfere with installation of the bowl.

1. Install mounting flanges for the Barracuda Max plastic funnel. These flanges need to be installed at the same height, as indicated by model in Table 1. For example, the anchor holes for S4 flanges should be drilled 77" (1925 mm) from the sump floor. S4 and S6 models have four flanges and they need to be evenly spaced at 12, 3, 6, and 9 o'clock positions. S8 funnels require eight flanges that also need to be evenly spaced (i.e., forty-five degrees on a circle) around the inside of the manhole. This flange points are typically located in the third manhole section from the sump and also contain the pipe openings for the Barracuda Max unit. Use the same anchor procedure as you will when mounting the teeth (see step #4 below), using the 1/4" (6.25 mm) concrete drill bit to drill 1 1/4" (31.25 mm) deep holes. Do not over drill the depth of the anchors. Lightly hammer the anchors in place and use locking nuts to firmly secure the flanges (Figure 1).
2. Next, mount the four sets of teeth vertically inside the manhole sump. Using the engineer's plans or the ADS layout, determine the correct orientation for the plastic funnel outlet hole in relation to the outlet pipe (Figures 2 and 5). The first set of teeth (marked as "A" on the teeth part) will be mounted under the center of the outlet hole from the Bowl. Mark that location with a plumb vertical line, this will serve as the "12 o'clock" landmark in the manhole (Figure 3). Repeat this process to mark lines at the 3, 6, and 9 o'clock positions for a total of four.
3. Each kit includes four sets of teeth. Two of these sets are stamped with the letters A and C. The other two sets are stamped B and D. The ADS shop drawing layout will label the teeth letters and all designs will be the A/B configuration (Figure 5). You will install each set of teeth in the correct location, with the indicated letter facing up (Figure 4). See Table 1 for the correct elevation for the top anchor location of each tooth set, measured from the sump floor for each Barracuda Max Unit. The teeth anchors are all at the same elevation. For example, for an S4 Barracuda the top anchor of an A or B indicated set of teeth will be 60" (1500 mm) off the sump floor. Mark the top anchor elevations on each of your four vertical lines (Figure 3), noting that A and B sets of teeth will be at the same height.



Figure 1



Figure 2



Figure 3

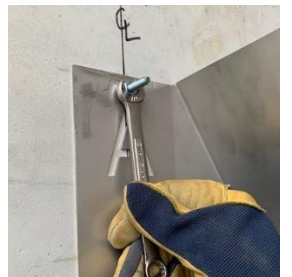
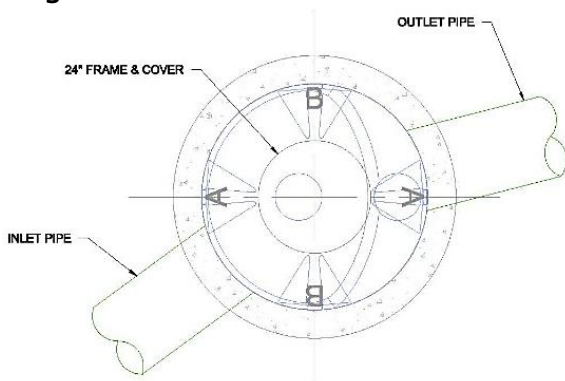

Figure 5

Figure 4



4. To fasten the sets of the teeth to the manhole, use the ¼" concrete drill bit and drill holes approximately 1¼" (31.25 mm) deep at your marked top anchor locations. Do not over drill into the concrete wall. Using a hammer, lightly tap the concrete anchors into the drilled holes (Figure 4). Hang the tooth set on the top anchor with the correct letter facing up and use a locking nut to loosely secure the tooth set to the wall (do not fully tighten the locking nut at this point). With the set of teeth hanging from the top anchor, line up and mark the bottom anchor location and drill the hole. Then hammer the bottom anchor in place and secure the teeth with a lock nut. Use an adjustable or socket wrench to tighten all the top and bottom locking nuts, except for the top nut on the outlet set of teeth (see step #5 below for the deflector plate installation, which will share the top anchor post), so that the teeth are firmly secured to the wall.
5. To attach the deflector plate to the concrete manhole you will use the exit tooth's top concrete anchor and share that linking point with the center tab of the deflector plate. Place the center tab of the deflector plate over the anchor bolt "post" on the outlet set of teeth and hand tighten the nut. Ideally, the plate will be held in place by this center point. Mark the location of the additional mounting tabs for the deflector plate while holding the plate relatively level. All deflector plate concrete anchors will be at the same elevation as the top tooth linking points and the anchors will be installed like the description in step #4. Once the two outer deflector plate linking points have been located, the installer can draw a vertical line and measure the exact location corresponding to the "high" teeth anchoring elevation. Once the deflector plate concrete anchors are installed tighten the nuts to complete the fastening of the deflector plate to the wall of the structure. See Figure 6 to show this more clearly.
6. Lower the plastic funnel into the structure (Figure 7), orienting the weir and outlet hole as depicted in the ADS layout (as identified in step 1). S6 and S8 units have eyebolts threaded holes on the top of the funnel to assist in lifting, and the eyebolts are provided in the equipment kit. If the eyebolts are misplaced, S6 units have ¾" (9 mm) -16 threads and S8 units utilize ½" (12 mm) -13 threads. After the bowl is in place, install the center funnel extender through the hole and seat it until the tabs of the extender touch the bowl itself (Figure 8). This is a friction-based attachment and no fasteners are needed.
7. Next, you'll use Conseal to fill any gaps around the funnel. S6 and S8 units are provided with a metal funnel plug. This plug is placed in the funnel opening for worker safety and must be utilized ANYTIME SOMEONE ENTERS THE STRUCTURE. Unroll the Conseal and wedge it between the funnel and manhole to create a seal (Figure 9). Conseal should also be used to seal between the vertical edges of the weir wall and the manhole. The plastic funnel can expand with high temperature. Install the funnel during cooler parts of the day, or keep the funnel shaded until installation can mitigate fitment issues. Once the Conseal is installed, the internal component installation is complete. The funnel plug may be discarded (if applicable), and the top slab can be set. If the application calls for a grated inlet, orient the slab so the grate is above the inlet (large bowl) side of the plastic funnel.



Figure 6

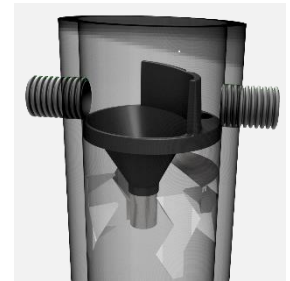

Figure 7



Figure 8

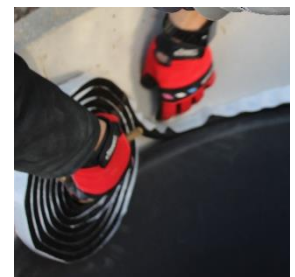

Figure 9

For maintenance details, please refer to the Barracuda Max Maintenance Manual. If the application requires a trash rack or oil boom, reference the appropriate supplementary installation instructions.

Table 1

	S4	S6	S8
Top Anchor Elevation from Sump Floor (A and B tooth indication)	60" (1270 mm)	68" (1475 mm)	90" (1880 mm)
Funnel Flange Anchor Elevation from Sump Floor	77" (1960 mm)	77" (1960 mm)	127" (3220 mm)

Note: Distances can be +/- 1-2 inches (25-50 mm) from these locations for the A, and B teeth, but flange elevations should be adhered to as much as possible and can only be lowered a maximum of 1 inch (25 mm) from these values listed above.

This guide is intended for field installations of Barracuda Max S4, S6, and S8 water quality units into precast manholes. For pre-casters installing internal components prior to job site delivery, contact ADS for possible modifications to component elevations.

