

3099CGRDFL & 3099CGRFHL

DRILL Ø .438 THRU GRATE ONLY
COUNTERBORE Ø 1.00 X .275 DP
2 PLACES

DRILL Ø .313 THRU
TAP 3/8-16 THREAD
2 PLACES

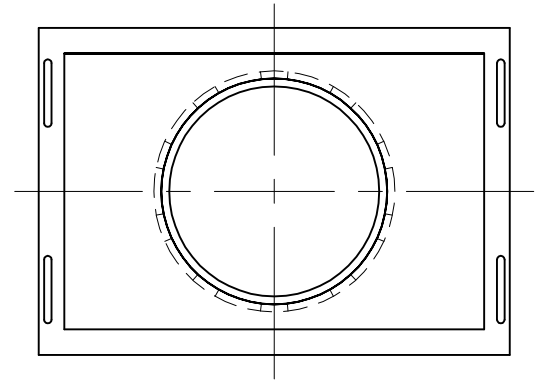
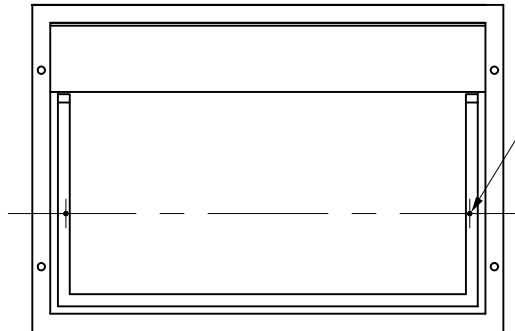
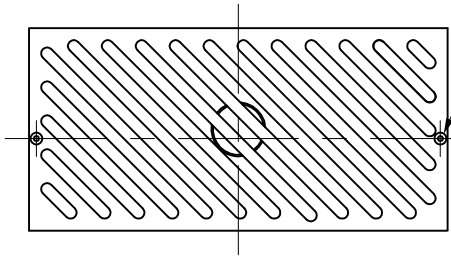

3/8-16 X 2 1/4" LONG HEX BOLT
ZINC-PLATED STEEL 2 PLACES

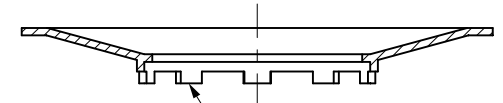
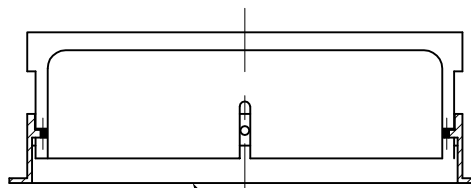
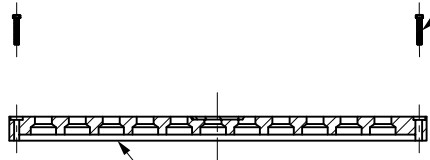

2' X 3' CURB INLET DIAGONAL LOCKING GRATE
3099CGRDFL

2' X 3' CURB INLET LOCKING FRAME & HOOD
3099CGRFHL

2' X 3' CURB INLET BASE PLATE
TO MATCH BASIN O.D.

NOTE: LOCATION OF LOCKING DEVICE MAY VARY

THIS PRINT DISCLOSES SUBJECT MATTER IN WHICH NYLOPLAST HAS PROPRIETARY RIGHTS. THE RECEIPT OR POSSESSION OF THIS PRINT DOES NOT CONFER, TRANSFER, OR LICENSE THE USE OF THE DESIGN OR TECHNICAL INFORMATION SHOWN HEREIN REPRODUCTION OF THIS PRINT OR ANY INFORMATION CONTAINED HEREIN, OR MANUFACTURE OF ANY ARTICLE HEREFROM, FOR THE DISCLOSURE TO OTHERS IS FORBIDDEN, EXCEPT BY SPECIFIC WRITTEN PERMISSION FROM NYLOPLAST.

©2013 NYLOPLAST

DRAWN BY	EBC	MATERIAL
DATE	03-27-06	
REVISED BY	CCA	PROJECT NO./NAME
DATE	09-05-13	
DWG SIZE	A	SCALE 1:16 SHEET 1 OF 1

	3130 VERONA AVE BUFORD, GA 30518 PHN (770) 932-2443 FAX (770) 932-2490 www.nyloplast-us.com
	TITLE 2 FT X 3 FT CURB INLET DIAGONAL LOCKING GRATE ASSEMBLY
DWG NO.	7002-110-057 REV C