

DESIGNED TO FIT 24" DIAMETER
NYLOPLAST PVC DRAIN BASIN

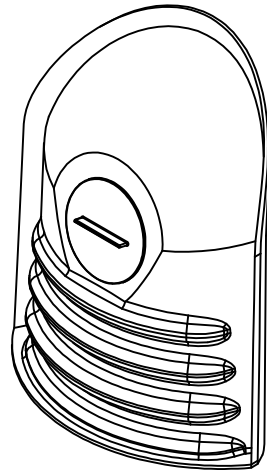

REMOVABLE 6"
ACCESS PORT

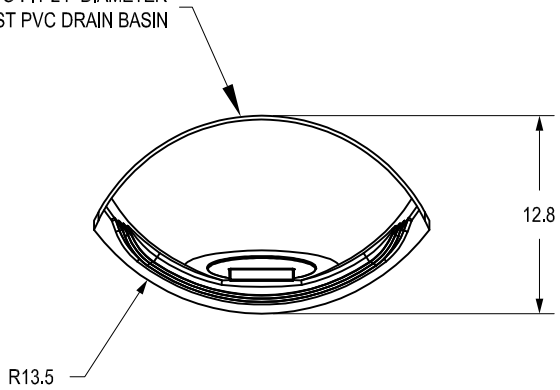
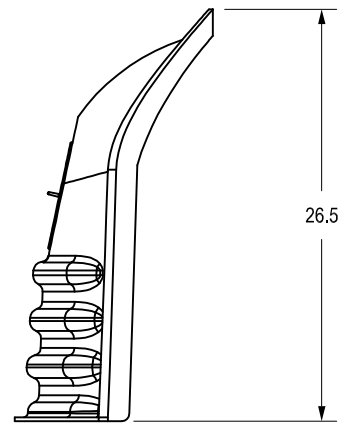
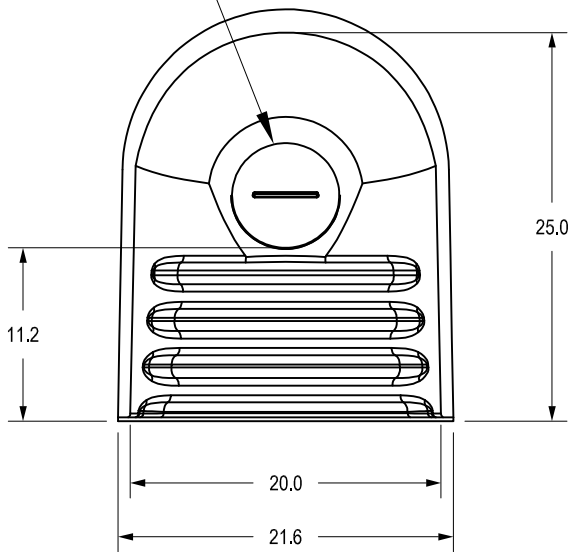

THIS PRINT DISCLOSES SUBJECT MATTER IN WHICH NYLOPLAST HAS PROPRIETARY RIGHTS. THE RECEIPT OR POSSESSION OF THIS PRINT DOES NOT CONFER, TRANSFER, OR LICENSE THE USE OF THE DESIGN OR TECHNICAL INFORMATION SHOWN HEREIN. REPRODUCTION OF THIS PRINT OR ANY INFORMATION CONTAINED HEREIN, OR MANUFACTURE OF ANY ARTICLE HEREFROM, FOR THE DISCLOSURE TO OTHERS IS FORBIDDEN, EXCEPT BY SPECIFIC WRITTEN PERMISSION FROM NYLOPLAST.

©2012 NYLOPLAST

DRAWN BY JJC
DATE 07-02-12
APPD BY JJC
DATE 07-02-12

REV BY CJA
DATE 08-20-14
APPD BY CJA
DATE 08-20-14

DWG SIZE A

MATERIAL
HIGH DENSITY POLYETHYLENE

PROJECT NO./NAME

SCALE NTS SHEET 1 OF 1



3130 VERONA AVE
BUFORD, GA 30518
PHN (770) 932-2443
FAX (770) 932-2490
www.nyloplast-us.com

TITLE
NYLOPLAST 24" ENVIROHOOD FOR UP TO 15" OUTLET

DWG NO. 7004-110-106 REV B