

DUAL WALL FABRICATED 60° REDUCING WYES
42"x4" - 42"x10" DIAMETER

PART #	PIPE SIZE	A	B	C	JOINT
4280AN60	42 x 4 in (1050 x 100 mm)	51.9 in (1318 mm)	33.5 in (850 mm)	39.7 in (1009 mm)	*
4280AN6065B	42 x 4 in (1050 x 100 mm)	41.5 in (1055 mm)	32.8 in (833 mm)	34.5 in (877 mm)	WT
4281AN60	42 x 6 in (1050 x 150 mm)	51.9 in (1318 mm)	34.5 in (875 mm)	39.7 in (1009 mm)	*
4281AN6065B	42 x 6 in (1050 x 150 mm)	41.5 in (1055 mm)	33.7 in (856 mm)	34.5 in (877 mm)	WT
4282AN60	42 x 8 in (1050 x 200 mm)	57.1 in (1450 mm)	36.2 in (919 mm)	42.3 in (1075 mm)	*
4282AN6065B	42 x 8 in (1050 x 200 mm)	46.7 in (1186 mm)	35.2 in (894 mm)	37.1 in (943 mm)	WT
4283AN60	42 x 10 in (1050 x 250 mm)	57.1 in (1450 mm)	38.9 in (987 mm)	42.3 in (1075 mm)	*
4283AN6065B	42 x 10 in (1050 x 250 mm)	46.7 in (1186 mm)	37.6 in (955 mm)	37.1 in (943 mm)	WT

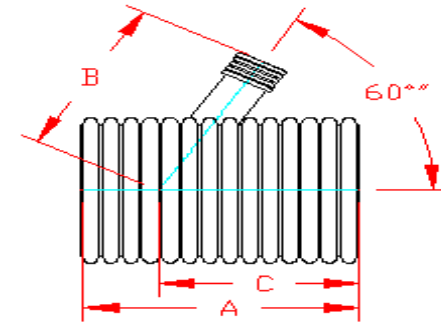

PLAIN END

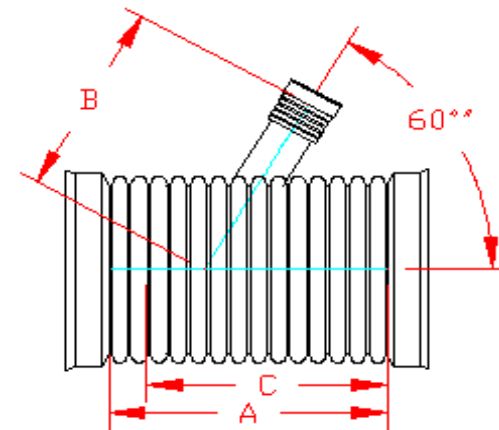

WT (INCLUDES 3 GASKETS)

* = PLAIN END
 ST = SOIL TIGHT
 WT = WATER TIGHT

NOTE: ALL FITTINGS DIMENSIONS ARE FOR REFERENCE ONLY

© 2023 Advanced Drainage Systems, Inc.



DRAWING #:	2380	
DRAWN BY:	JCB	04.20.06
APPROVED BY:	JCB	06.26.07
REVISIONS:	NJP	06.14.07