

Stormwater & Rainwater Harvesting Guide



Water Management and Reuse Solutions

Advanced Drainage Systems (ADS) and Rainwater Management Solutions (RMS) are working together to provide turn-key stormwater and rainwater harvesting solutions for commercial, industrial, and residential applications. Together, they're able to provide sustainable, high-quality systems for stormwater and rainwater management by combining the knowledge and experience each company has acquired in their respective sectors.



Stormwater Management and Reuse Applications and Benefits

Stormwater and rainwater management has become a critical element in new construction and retrofits to control runoff from increasingly large areas of impervious surfaces. The ability to not only store water runoff, but to collect and reuse has become a vital step towards sustainability and water conservation.

Outdoor Applications

- Irrigation
- Pool/Pond Filling
- Water and Landscape Features
- Street Cleaning/Dust control
- Fire Suppression
- Sanitary Sewer Flushing
- Vehicle washing

Indoor Applications*

- Toilet/Urinal Flushing
- Laundry Services
- Cooling Towers
- Process/Boiler Water
- Fire Suppression
- Utility Wash Water

* Jurisdiction specific and require additional treatment/disinfection in most areas

Managing Stormwater can help meet regulatory guidelines by utilizing the following methods:

- Volume Reduction: Retaining stormwater on-site and reducing the capacity and size of on-site detention
- Rate Control: Slowing water discharge to the drainage system which mitigates flooding and erosion
- Water Quality: Pre-treatment to address contaminants (e.g. filtration for gross solids, phosphorous, metals and oil/grease)
- Land Use Optimization: Help to reduce the amount of land required for traditional detention systems, allowing for the sale of additional lots and property

Stormwater Harvesting vs Rainwater Harvesting



Stormwater Harvesting

Requires additional treatment than rainwater harvesting for onsite re-use. Nationally, stormwater harvesting is growing in acceptance and use.



Rainwater Harvesting

Typically roof collection and storage for onsite re-use. Once the rainwater hits the ground, it is considered stormwater.

Integrated Systems for Water Harvesting

Systems can be configured to collect water from an ADS water quality product for storage in holding tanks. The overflow from both the tank and water quality product can then be routed to a filtration system to optimize the water savings. Above-ground tank configurations are available as well.

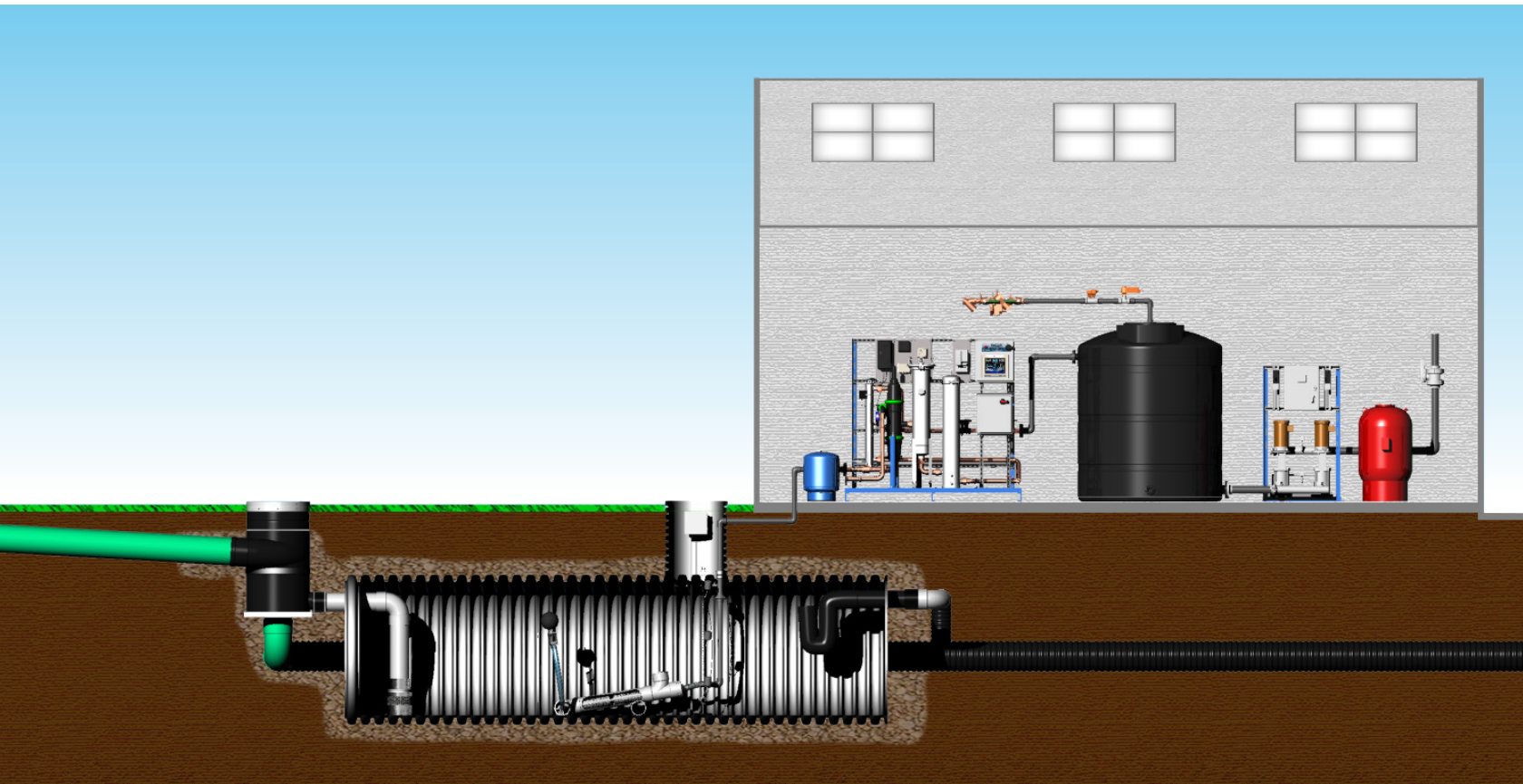
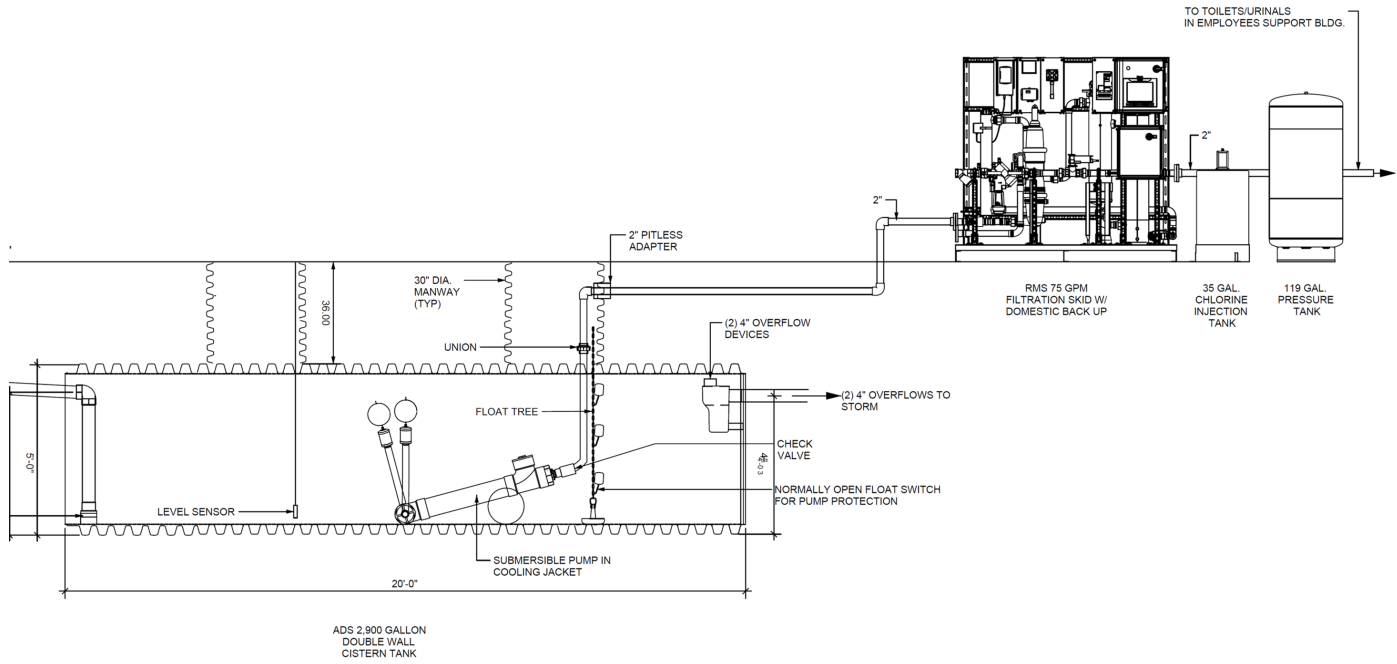

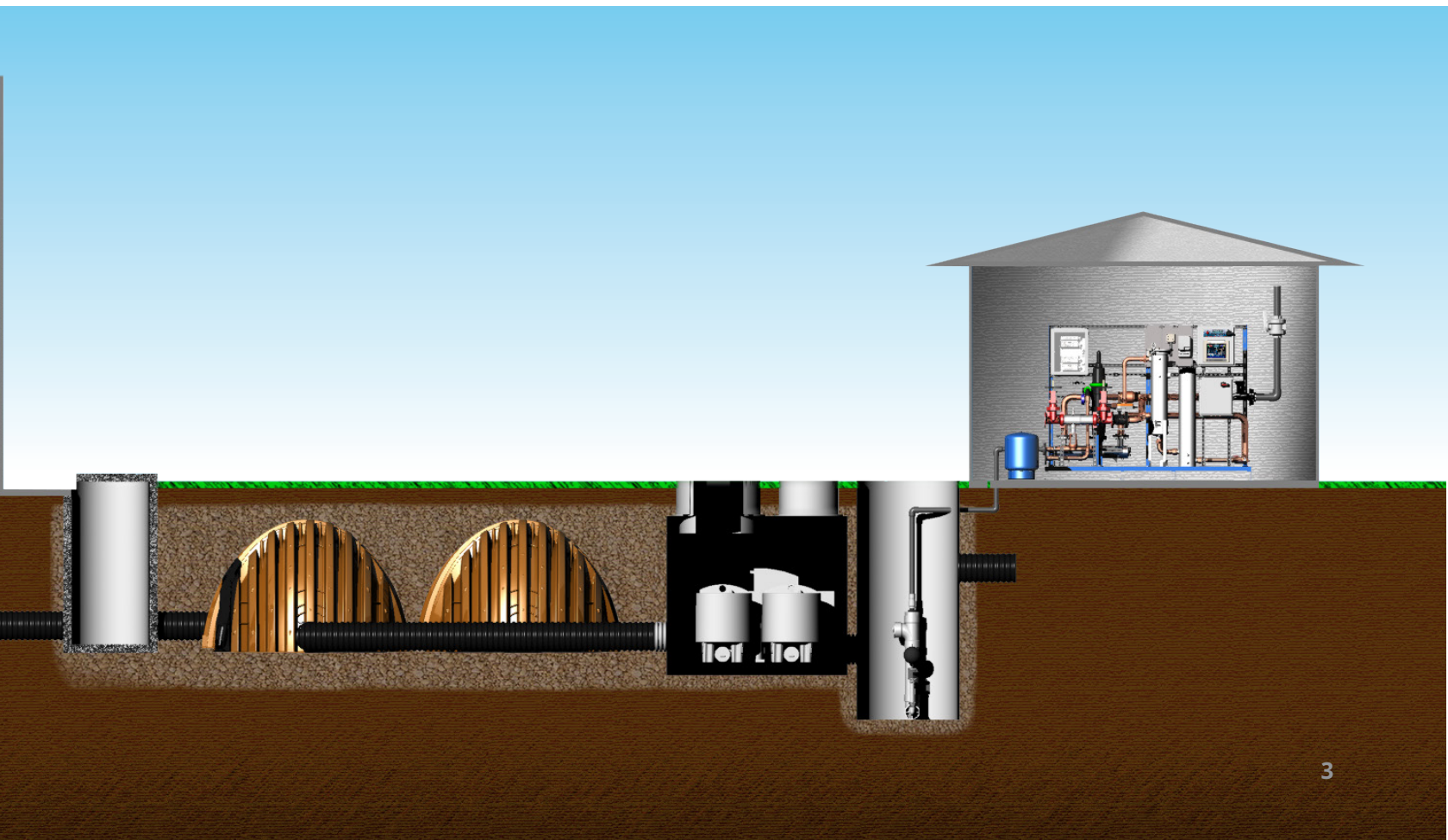
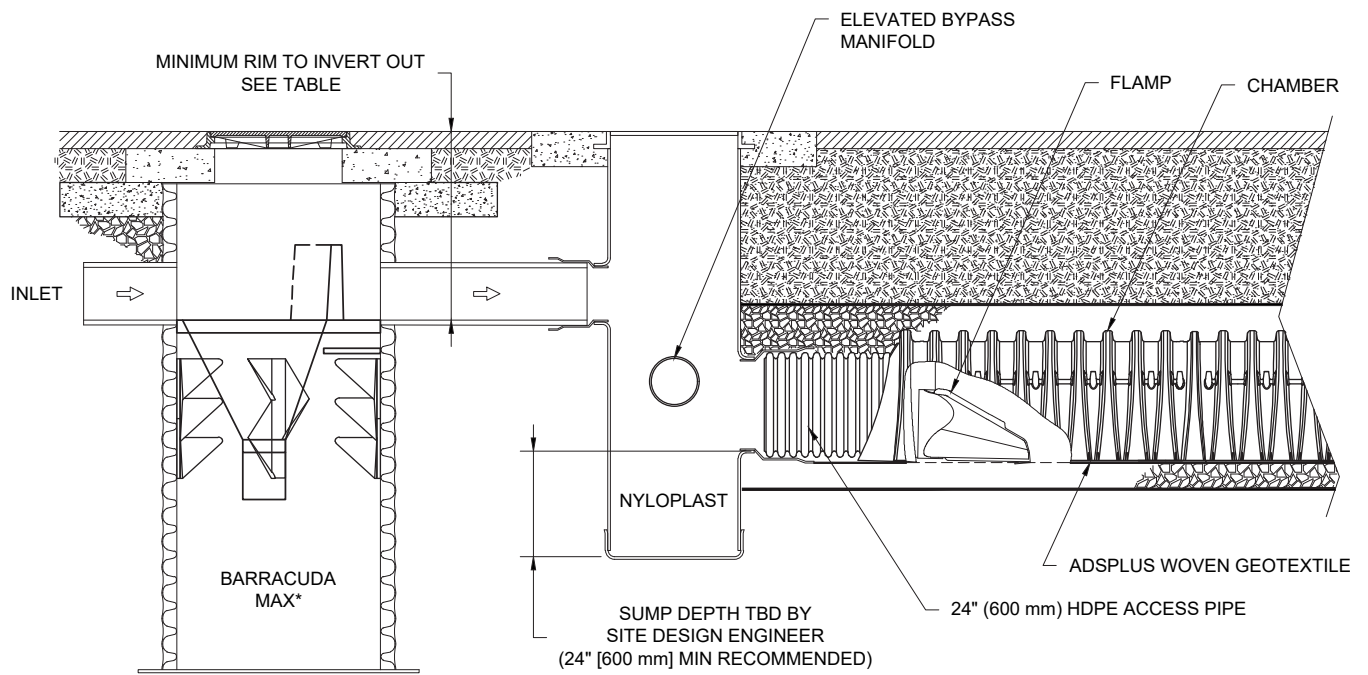

4-Step Rainwater Harvesting Process

1. Pre-tank Filtration

A pre-tank water harvesting filter has one inlet, a filtered water outlet and a debris/overflow outlet. These low maintenance filters prevent unfiltered water from entering the storage system. Pre-filtration devices reduce the amount of debris entering the tank, promote a healthy tank environment, and reduced system maintenance. The polyethylene construction allows for direct burial. Load rated lids are available. Above grade installation is possible with available mounting brackets. Pressure rated stainless steel units are also available.

These filters are available in the following sizes:



4" (100 mm)
WFF 100

280-micron filtration from up to 2,100 ft² (195 m²)



6" (150 mm)
WFF 150

280-micron filtration from up to 5,500 ft² (511.0 m²)



12" (300 mm)
WFF 300

380-micron filtration from up to 33,000 ft² (3,065.8 m²)



Learn more about rainwater filters

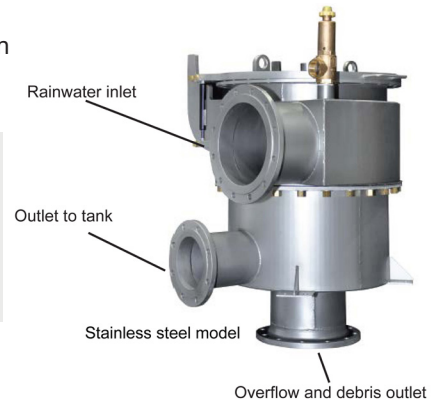
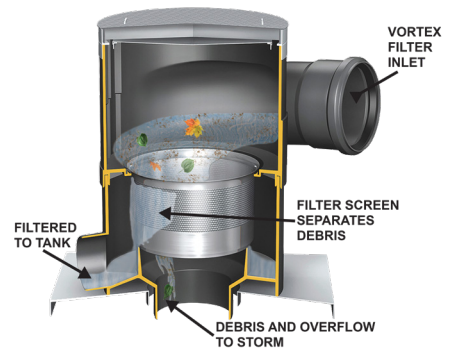

Pre-tank filters do not allow debris larger than 400 micron to enter the tank under any circumstances. Pre-tank filters are highly efficient when sized correctly, generally with approximately 95% of the water being sent to storage in most applications. The pre-tank filters are sized based on the catchment area and rainfall data for the specific location.

High Volume (HV) Filters

RMS HV pre-tank filters are designed to filter high volumes of water from roof areas up to 200,000 square feet. Sizes range from 6" to 24" with bottom and side filtered water outlets available. These products are available with slip fittings or flange fittings. Optional spray nozzles clean the filter element. Multiple levels of sediment removal are offered.

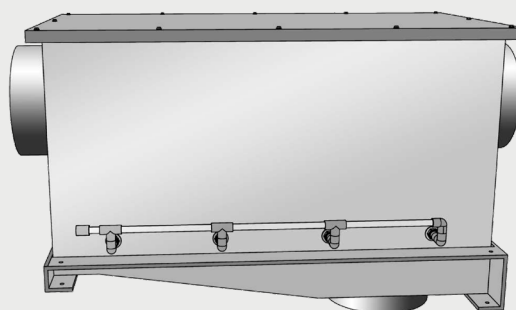
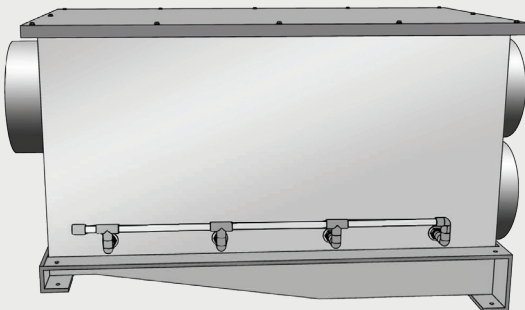

2. Smoothing Inlet

Smoothing inlets gently introduce water into the tank, helping to prevent unnecessary turbulence. The inflow of water also oxygenates the tank. These functions help to ensure optimal water quality. Smoothing inlets are available in the following sizes:

- 4" (100 mm) inlet
- 8" (200 mm) inlet



3. Floating Intake

Floating intake devices draw water from the tank to be sent for treatment. The intake device floats just below the surface of the water, where the water is cleanest. This ensures optimal water quality being sent to treatment. These devices come in multiple sizes and filtration intensities in multiple sizes and filtration intensities. Floating intakes are available in the following intake sizes and filtration sizes:

- 1" (25 mm) inlet
- 1 1/4" (31 mm) inlet
- 2" (50 mm) inlet
- 1,200-micron filtration
- 300-micron filtration



4. Overflow Device

Overflow devices skim and remove floating particles from the water's surface, helping to protect water quality inside the tank. They are designed with vermin prevention and back-flow prevention capabilities. They also prevent storm drain odors from entering the tank. Overflow devices are available in the following sizes:

- 4" (100 mm) inlet
- 8" (200 mm) inlet

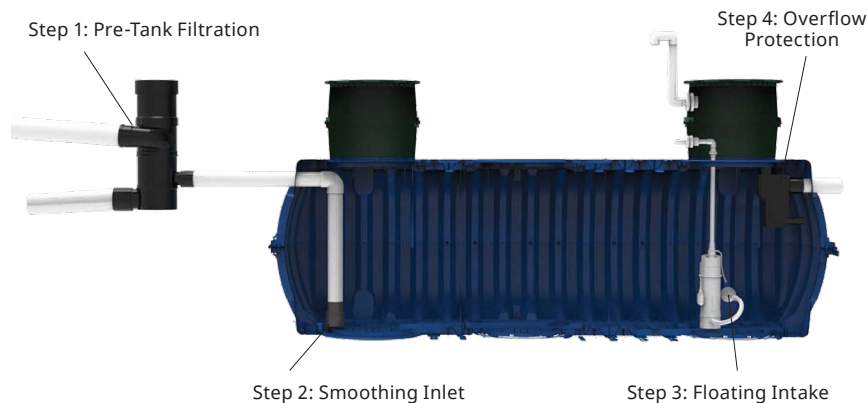

Learn more about
WISY 4- Step Process



Stormwater Management Pre-Filtration

EcoStream™ BioFilter

The EcoStream BioFilter is a leader in the Biofiltration stormwater treatment market. This high flow, low impact system incorporates the processes of sedimentation, filtration, adsorption, and biological treatment. The ADS EcoStream BioFilter is designed to capture and retain a variety of pollutants including sediment, nutrients, heavy metals, and hydrocarbons while helping to meet green infrastructure objectives. Boasting a small footprint and high flowrate, the EcoStream BioFilter offers high value and outstanding performance.

- High filter media area and flowrate
- Low elevation change between the inlet and outlet of the system
- Superior removal mechanisms utilizing physical unit operations and biological processes
- Living plant component on the surface of the unit
- Internal bypass



Barracuda Max Stormwater Separator

The Barracuda is a market changing stormwater quality technology. A high-performance, vortex hydrodynamic separator, the Barracuda removes total suspended solids (TSS).

- Single manhole design
- No elevation loss between the inlet and outlet
- Flexible inlet/outlet positions (not just 180 degree orientation)
- Internal bypass for inline installation (where applicable)
- Revolutionary, patent-pending “teeth” mitigate turbulence in the sump area to prevent resuspension of captured contaminants
- Easy maintenance using a vacuum truck or similar equipment
- Surface inspection and maintenance with no confined space entry



Barracuda 3D Design Tool

Assists in the sizing and design of the ADS Barracuda hydrodynamic separator, which removes total suspended solids (TSS) and other contaminants from stormwater.

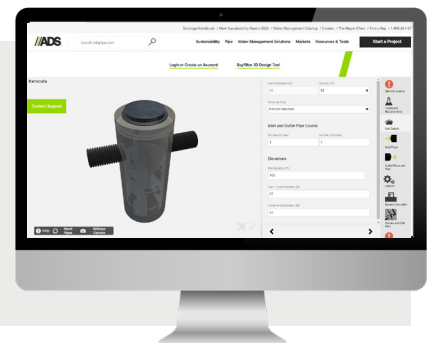

Stormwater Management Pre-Filtration

EcoPure BioFilter®

EcoPure BioFilter is a high performance, low impact system designed to remove most traditional pollutants from urban stormwater. It merges pretreatment of impervious stormwater runoff with advanced filtration of both surface and subsurface runoff sources. The device is suitable for both new construction and retrofit applications with a quick, simple installation.

- High filter media area and flowrate
- Linear treatment design with an upfront pretreatment cell.
- Low elevation change between the inlet and outlet of the system
- Superior removal mechanisms utilizing Physical unit operations, Chemical/Biological processes
- Living plant component at the surface of the unit
- Internal bypass for inline installation (where applicable)



BayFilter Stormwater Media Filter

The state of the art stormwater filter effectively removes pollutants such as TSS, phosphorus, metals, nitrogen, trash, and hydrocarbons. The compound spiral media configuration allows for a large filter surface area in a compact footprint. This configuration results in the most efficient and effective stormwater filter available in the marketplace. The BayFilter is available in multiple sizes and media configurations to meet any flow rate and any pollutant constraints. A BayFilter System is typically a concrete structure (precast vault, manhole, or cast in place structure) with a single or multiple BayFilter cartridges.

- Approved by WADOE and NJDEP
- Longest service life of any cartridge filter with the ability to treat over 300 pounds of sediment
- Spiral design provides a large filter surface area
- Ability to treat TSS, phosphorus, dissolved metals and other pollutants
- Customizable systems

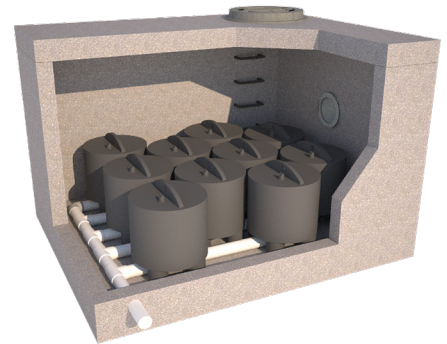

BayFilter 3D Design Tool

Provides a real time 3D rendering input with structure information to see how the product will fit into a project.

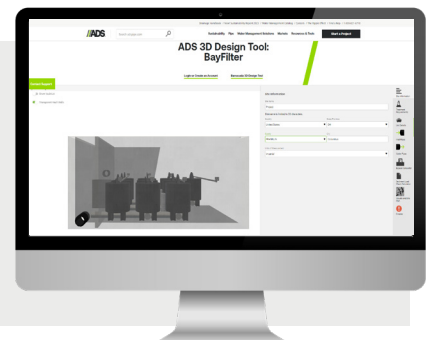

Conveyance to Storage

HP & HDPE Storage Systems

These modular systems can be specially designed to hold more than a million gallons under a huge warehouse, or to fit in the smallest of footprints. ADS can help minimize domestic water use while reducing stormwater runoff volumes. ADS Storage Systems are customizable, offering rainwater harvesting and retention that can release water through a controlled outlet or hold water until the surrounding soil can accept infiltration. These systems are available with easy maintenance, pre-treatment, and clean-out options. ADS storage systems are constructed from HDPE and inert polypropylene material, and are assured of a long service life.

Customizable

A variety of fitting options for site-specific design and application.

Maximum Storage

Sizes up to 60" (1500 mm) in diameter. A variety of standard sizes and volumes are offered, but custom sizes are always available as well.

HP Rain Tank Dimensions and Specifications

I.D. in (mm)	Length ft (m)	Tank Capacity		
		gal	ft ³	L
36 (900)	40 (12)	1,477	197	5,591
	60 (18)	2,215	296	8,385
42 (1050)	40 (12)	2,169	290	81,990
	60 (18)	3,254	435	12,318
48 (1200)	40 (12)	2,982	399	11,288
	60 (18)	4,474	598	16,936
60 (1500)	40 (12)	4,966	664	18,798
	60 (18)	7,449	996	28,198



Infiltrator® Tanks

Non-Potable Tank

The strength and versatility of Infiltrator non-potable tanks enable a wide range of installation possibilities, including shallow installations and multiple and serial tank configurations. Infiltrator's lightweight construction allows for easy storage and delivery, and offers the quickest installation in the on-site wastewater industry. The engineered mid-seam joint accepts a continuous loop EPDM gasket. Infiltrator's EPDM gasket design utilizes technology and materials from the sanitary sewer pipe industry to deliver a reliable watertight seal. The two-piece tank body is permanently aligned and fastened using an integrated system of high strength plastic alignment dowels and locking seamclips. The tank does not require water filling during installation and can be pumped dry during pump-outs.



- Lightweight plastic construction
- Inboard lifting lugs allow for easy delivery and handling
- Structurally reinforced access ports eliminate distortion during installation and pump-outs
- Reinforced structural ribbing and fiberglass bulkheads offer additional strength
- Can be pumped dry during pump-outs (no need to refill with water)
- Suitable for use as a septic tank, trash tank, pump tank, or rainwater (non-potable) tank, in-series or multiple serial tank configurations

IM-Series Potable Water/ Rainwater Harvesting Tank

The Infiltrator IM-Series potable water tanks are lightweight, strong and durable. These potable, watertight cisterns are offered with Infiltrator's potable heavy-duty lids. Infiltrator injectionmolded tanks provide a revolutionary improvement in plastic tank design, offering exceptional long-term strength and watertightness.



- Lightweight plastic construction
- Inboard lifting lugs allow for easy delivery and handling
- Structurally reinforced access ports eliminate distortion during installation and pumpdowns
- Reinforced structural ribbing and fiberglass bulkheads offer additional strength
- Suitable for use as a potable pump tank, rainwater harvesting or water storage tank

Additional Tank Solutions

RMS provides a wide range of storage solutions, both above and below ground. Tanks can be made from a variety of materials to best fit any job: concrete, fiberglass, stainless steel, corrugated steel with liners, and more.

Scalable Volume Storage

StormTech Chambers

StormTech Chambers reduce installed costs of underground detention systems, meet land-use requirements and stay on budget.

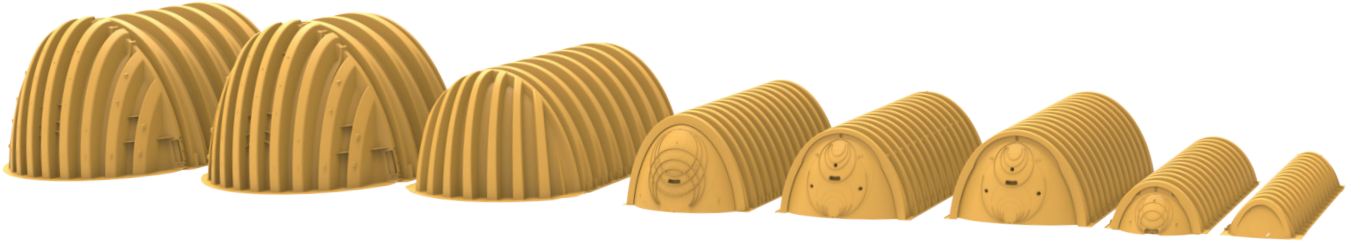

MC-7200

MC-4500

MC-3500

SC-800

DC-780

SC-740

SC-310

SC-160LP

- Most cost-effective subsurface detention/retention system
- High quality injection molded polypropylene chambers
- Designed to meet all the AASHTO requirements for live load and earth load design
- Large storage volume per cubic foot
- Lightweight for easy construction and superior production rates for installation
- Pipe manifold design based on accepted engineering techniques to assure conveyance capacity for peak flows
- Isolator® Row Plus enhances TSS removal and provides easy access for inspection and maintenance
- Option to add impermeable liner encasing chambers to create a detention system



StormTech Design Tool

Generates detailed & customized chamber layouts for today's fast-paced environment. Save or modify your project to your online account for future use.

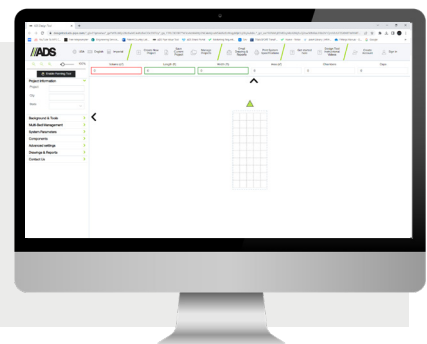

Isolator[®] Row Plus

The StormTech Isolator Row Plus is an enhancement to our proven water quality treatment system. This updated system is an NJCAT verified water quality treatment device that can be incorporated into any system layout.

Features

- Isolator Row Plus is now NJCAT verified. As a Manufactured Treatment Device it achieves over 80% TSS removal by filtration NJDEP Laboratory Protocol Assessment NJCAT Technology Verification.
- A patented Flamp[™] (Flared End Ramp) provides a smooth transition from pipe invert to fabric bottom. The Flamp is attached to the inlet pipe inside the chamber end cap and improves chamber function over time by distributing sediment and debris that would otherwise collect at the inlet. It also serves to improve the fluid and solid flow back into the inlet pipe during maintenance and cleaning.
- Proprietary ADS Plus fabric maintains durability and sediment removal while allowing for higher water quality flow rates. A single layer of ADS Plus fabric is placed between the angular base stone and the Isolator Row Plus chambers.



Technology Descriptions

The Isolator Row Plus is designed to capture the “first flush” runoff and offers the versatility to be sized on a volume or a flow rate basis. An upstream manhole not only provides access to the Isolator Row Plus but includes a high/low concept such that stormwater flow rates or volumes that exceed the capacity of the Isolator Row Plus bypass through a manifold to the other chambers. This is achieved with either an elevated bypass manifold or a high-flow weir. This creates a differential between the Isolator Row Plus row of chambers and the manifold to the rest of the system, thus allowing for settlement time in the Isolator Row Plus. After Stormwater flows through the Isolator Row Plus and into the rest of the StormTech chamber system, it is either infiltrated into the soils below, passed at a controlled rate through an outlet manifold and outlet control structures, or stored for harvesting/reuse applications.

Schematic of the StormTech Isolator Row Plus System

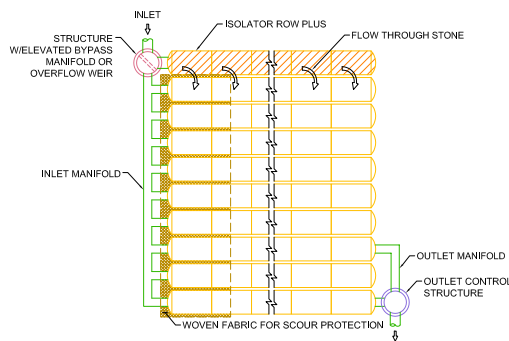

Summary of Verified Claims¹

Treatment Rate (gpm/ft ²)	4.1
Underlying Geotextile Layers	1
NJDEP Test Sediment	1-1000 μ
Mean Particle Concentration (mg/L)	200
TSS Removal Efficiency	>80%

¹ Verification testing of the StormTech SC-740 Isolator Row PLUS in accordance with NJDEP Laboratory protocol to access total suspended solids removal by filtration manufactured treatment device, 2013

StormTech Isolator Row Plus (not to scale)

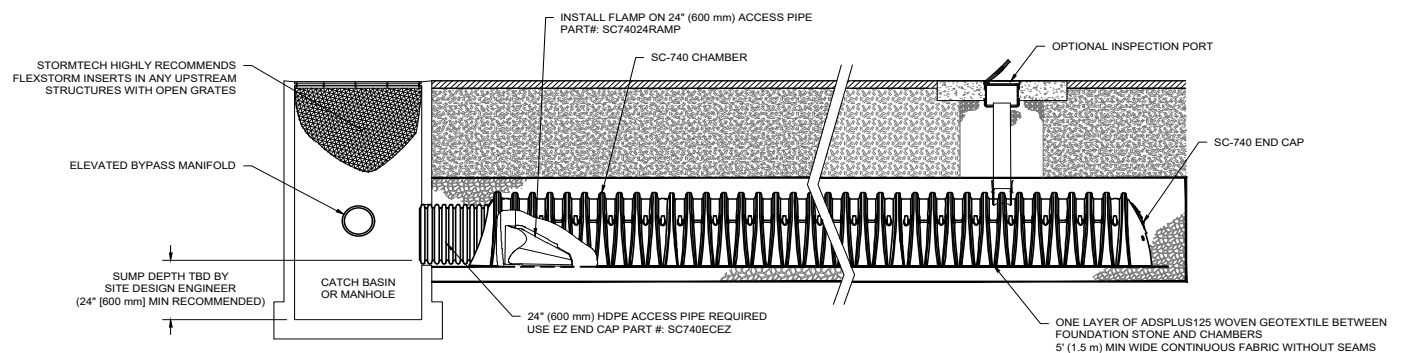

Creating a Complete Water Harvesting System

Application Design

The equipment for the filtration packages has been selected based on flow-rate capacity. As such, each package is named by the maximum flow rate capacity. Standard filtration packages range from 25 gallons per minute to 200 gallons per minute, available in 25 GPM increments. Maximum operating pressure is to be 125 PSI, with minimal operating pressure to be 30 PSI

When to use a Day Tank

In applications which require higher flow rates and/or higher pressures at the end use, it is recommended to use a "Day Tank" system. A transfer pump will pump water from the primary storage, through the filtration skid, for storage in a smaller "Day Tank". A booster pump can then draw water from the Day Tank and send it to the end use at the required flow rate and/or pressure.



Pumping Systems

RMS has pumps to meet a wide variety of horsepower and voltage demands for your project requirements. RMS builds custom, manufacturer approved cooling jackets to house large pumps and motors.

- Booster/Jet
- Submersible
- Recirculation
- Centrifugal
- Pump Enclosures

Modular Pump Packages

In addition to standard transfer pumps that provide water to a day tank or to end use, RMS can provide booster pump skids when the desired flow or pressure needs to be increased. Booster pump skids are also an ideal solution for flooded-suction applications. RMS has partnered with industry leaders to develop a variable frequency drive specifically for water harvesting. A variable frequency drive (VFD) reduces energy spikes by powering the motor at an adjustable rate. A VFD reduces wear and tear on your pump motor and provides more consistency on pressure/flow output from the pump. A custom macro in the VFD reduces on-site start-up to merely setting desired pressure.



System Design Form

Follow this QR code and submit the design questionnaire to take the first step in designing your rainwater system.



Modular Treatment Skids

RMS produces UL/CA certified treatment systems that address the following while becoming an essential plug and play component of the overall system.

1. Self-Cleaning/Back-Flushing Screen Filters remove large particulate.
2. Cartridge/Bag Housings provide secondary sediment filtration to the level of 5 microns.
3. Carbon Filtration reduces discoloration, odor and volatile organic compounds.
4. Ultraviolet Lights sterilize pathogens, preventing their reproduction, making the rainwater safe to use.
5. Integrated Backup Water Supply provides uninterrupted water to the end use if rainwater is depleted.
6. Flow meters provided for both rainwater and domestic sources.
7. Pressure Differential Transmitters signal when filters need to be serviced.
8. Single Point Power Source connects to building power and provides a single point disconnect and a step-down transformer to power 120V secondary and low voltage control wiring. Units are U.L./CA listed.
9. RMS 200 Controller is a custom-built PLC with graphical interface to display system health and control certain components. BAS interface provided through MODBUS or BACnet.
10. All equipment is mounted on an RMS skid made of powder coated carbon steel. The standard color is safety blue, but additional color options are available. Available piping materials include copper, schedule 80 PVC, stainless steel, CPVC, and PEX.

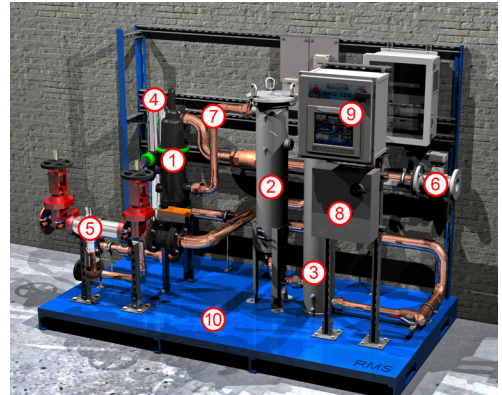

Specialty Treatment Solutions

RMS provides additional treatment solutions for any scenario, including ultrafiltration, reverse osmosis, ozone, and chemical injection.

RMS Controls

RMS produces touch-screen Programmable Logic Controllers that are constructed, programmed, and tested in its UL508A Panel Shop for the rainwater harvesting industry. RMS can directly assist with any controller operation needs, no third party is necessary. The RMS controls team provides guidance throughout design, construction, operation, and maintenance.

- RMS Series 200 Controller: 10.4" (260 mm) Screen
- RMS Series 200 Mini Controller: 5.7" (142.5) Screen
- Run light boxes are also available

These UL/CA listed PLCs are the "brains" behind advanced rainwater harvesting systems, monitoring digital and analog inputs, controlling outputs, displaying system information and integrating with building automation systems.





Francisco Park, San Francisco, Ca; (Front cover: StormTech Chambers being installed at Francisco Park).

Stormwater/Rainwater harvesting systems require expertise in design and execution. RMS and ADS are ready to help make your journey easy.

To contact the experts visit rainwatermanagement.com/pages/contact



Rainwater Management Solutions, Inc

2550 Shenandoah Ave NW
 Roanoke, VA
rainwatermanagement.com
 866-653-8337



Advanced Drainage Systems, Inc

4640 Trueman Blvd.
 Hilliard, OH
adspipe.com
 800-821-6710



ADS "Terms and Conditions of Sale" are available on the ADS website, www.adspipe.com
 Advanced Drainage Systems, Barracuda® Max, EcoStream™, EcoPure BioFilter®, the ADS logo and the Green Stripe are registered trademarks of Advanced Drainage Systems, Inc. Nyloplast is a registered trademark of Nyloplast, Inc. StormTech® and the Isolator® Row PLUS are a registered trademarks of StormTech, Inc. Rainwater Management Solutions Logo is a registered trademark of Rainwater Management Solutions. Infiltrator is a registered trademark of Infiltrator Water Technologies, LLC.
 © 2024 Advanced Drainage Systems, Inc. #11242 8/24 CS