

**DUAL WALL FABRICATED 60° REDUCING WYES**  
**36"×12" - 36"×24" DIAMETER**

PART #	PIPE SIZE	A	B	C	JOINT
3684AN60	36 x 12 in (900 x 300 mm)	63.0 in (1600 mm)	41.4 in (1050 mm)	43.5 in (1106 mm)	*
3684AN6065B	36 x 12 in (900 x 300 mm)	52.5 in (1334 mm)	39.4 in (1002 mm)	38.3 in (972 mm)	WT
3685AN60	36 x 15 in (900 x 375 mm)	63.0 in (1600 mm)	47.4 in (1203 mm)	43.5 in (1106 mm)	*
3685AN6065B	36 x 15 in (900 x 375 mm)	52.5 in (1334 mm)	44.8 in (1138 mm)	38.3 in (972 mm)	WT
3686AN60	36 x 18 in (900 x 450 mm)	68.3 in (1734 mm)	48.2 in (1224 mm)	46.2 in (1172 mm)	*
3686AN6065B	36 x 18 in (900 x 450 mm)	57.8 in (1467 mm)	45.5 in (1156 mm)	40.9 in (1039 mm)	WT
3687AN60	36 x 24 in (900 x 600 mm)	78.8 in (2000 mm)	52.4 in (1331 mm)	51.4 in (1306 mm)	*
3687AN6065B	36 x 24 in (900 x 600 mm)	68.3 in (1734 mm)	49.3 in (1251 mm)	46.2 in (1172 mm)	WT

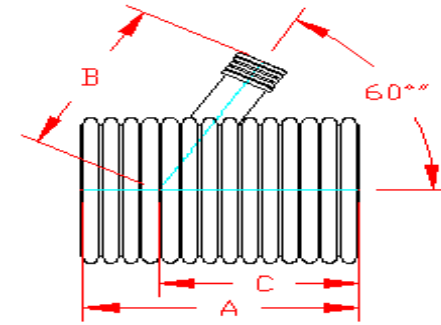

PLAIN END

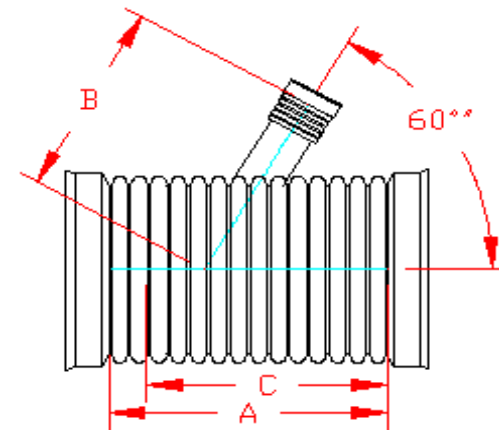

WT (INCLUDES 3 GASKETS)

\* = PLAIN END  
 ST = SOIL TIGHT  
 WT = WATER TIGHT

NOTE: ALL FITTINGS DIMENSIONS ARE FOR REFERENCE ONLY

© 2023 Advanced Drainage Systems, Inc.



DRAWING #:	2375A	
DRAWN BY:	JCB	04.20.06
APPROVED BY:	JCB	06.26.07
REVISIONS:	NJP	06.14.07