

# EcoStream Biofilter™

## Installation Guide

### Field and Pre-Install at the Precast Facility

**Note: EcoStream Biofilter is not recommended to be used as an erosion control device during site construction operations.**

EcoStream Biofilter should remain offline until site stabilization has occurred. Please contact your local ADS representative if you should have any questions.

#### Sections:

1. Material List
2. Precaster – Underdrain Kit and gravel installation
3. Site Contractor – Vault Installation
4. Site Contractor – EcoStream BioFilter Media Installation
5. Site Contractor – Final Field Installation Steps

### Material List

**Table 1:** Material list for EcoStream Biofilter

Model	Underdrain Kit <sup>a</sup>	Nominal Interior Vault Size ft x ft (m x m)	Filter Media Bags Half Sacks	Filter Media Bags Full Sacks	Flow Disk Size in (mm)	Overflow Riser <sup>b</sup> in (mm)	Beehive Grate <sup>b</sup> in (mm)	Growth Media ft <sup>3</sup> (m <sup>3</sup> )	No. 57 Washed Gravel lbs (kg)	Solid Cap for Standpipe <sup>c</sup> in (mm)
ES 4x4	1	4 x 4 (1.2 x 1.2)	0	1	2.3 (58.4)	6 (150)	6 (150)	7 (0.20)	1040 (471.7)	6 (150)
ES 4x6	1	4 x 6 (1.2 x 1.8)	1	1	2.8 (71.1)	6 (150)	6 (150)	10 (0.28)	1450 (657.7)	6 (150)
ES 4x8	1	4 x 8 (1.2 x 2.4)	0	2	3.25 (82.6)	6 (150)	6 (150)	14 (0.40)	1970 (893.6)	6 (150)
ES 4x10	2	4 x 10 (1.2 x 3.0)	1	2	3.6 (91.4)	6 (150)	6 (150)	17 (0.48)	2490 (1129.4)	6 (150)
ES 4x12	2	4 x 12 (1.2 x 3.7)	0	3	3.9 (99.1)	6 (150)	6 (150)	20 (0.57)	2900 (1315.4)	6 (150)
ES 6x8	2	6 x 8 (1.8 x 2.4)	0	3	3.9 (99.1)	6 (150)	6 (150)	20 (0.57)	2900 (1315.4)	6 (150)
ES 6x10	3	6 x 10 (1.8 x 3.0)	0	4	4.35 (110.5)	8 (200)	8 (200)	25 (0.71)	3630 (1646.5)	8 (200)
ES 6x12	3	6 x 12 (1.8 x 3.7)	1	4	4.75 (120.7)	8 (200)	8 (200)	30 (0.85)	4360 (1977.7)	8 (200)
ES 8x10	3	8 x 10 (2.4 x 3.0)	0	5	5.05 (128.3)	8 (200)	8 (200)	34 (0.96)	4880 (2213.5)	8 (200)
ES 8x12	4	8 x 12 (2.4 x 3.7)	0	6	5.50 (139.7)	10 (250)	10 (250)	40 (1.13)	5810 (2635.4)	10 (250)
ES 8x14	4	8 x 14 (2.4 x 4.3)	0	7	5.95 (151.1)	10 (250)	10 (250)	47 (1.33)	6850 (3107.1)	10 (250)
ES 8x16	4	8 x 16 (2.4 x 4.8)	0	8	6.35 (161.3)	10 (250)	10 (250)	54 (1.53)	7780 (3528.9)	10 (250)

*a – See underdrain kit installation section for more details*

*b – Part of underdrain kit*

*c – Optional to replace beehive grate when engineer's plans show an alternate bypass option*

1	Inlet pipe or throated inlet
2	Rip Rap
3	No 57 washed gravel
4	EcoStream Filter Media
5	Growth Media
6	Underdrain
7	Overflow Riser
8	Beehive Grate or solid end cap
9	Outlet Pipe

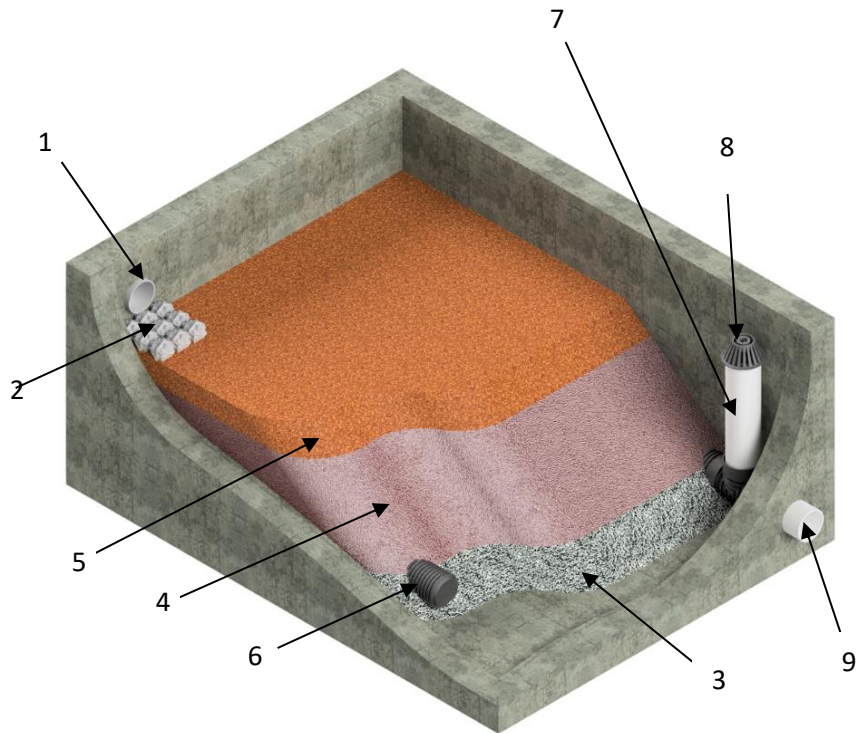

Figure 1: EcoStream Components

## Underdrain Installation

The underdrain system and overflow come in one of four different kits based on the EcoStream model. See the following Sections for detailed instructions:

Section 2.1	Kit 1	ES 4x4, ES 4x6, ES 4x8
Section 2.2	Kit 2	ES 4x10, ES 4x12, ES 6x8
Section 2.3	Kit 3	ES 6x10, ES 6x12, ES 8x10
Section 2.4	Kit 4	ES 8x12, ES 8x14, ES 8x16

### Underdrain Kit 1

1. Confirm the following pieces are in the Kit.
  - a. 6" (150 mm) PVC pipe 18" (450 mm) long (outlet pipe)
  - b. 6" (150 mm) Tee
  - c. 6" (150 mm) HDPE pipe 25" (625 mm) long (standpipe)
  - d. 6" (150 mm) Beehive grate
  - e. 6" (150 mm) solid end cap (for standpipe if applicable)
  - f. 6" (150 mm) HDPE split end cap (for underdrain)
  - g. Flow Disk
  - h. 6" (150 mm) HDPE perf pipe (10 ft min.)

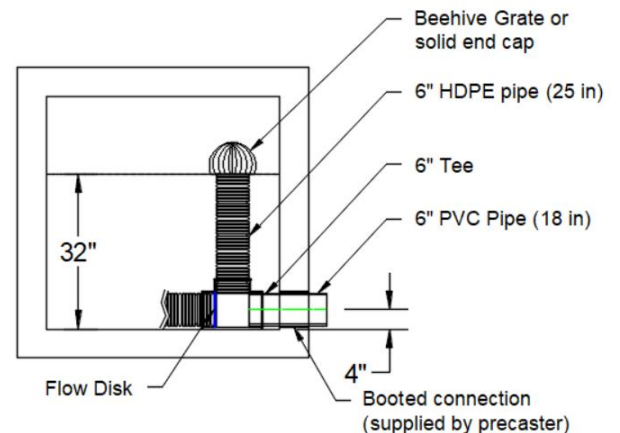

Figure 2: Underdrain Kit 1



**Figure 3:** Flow disk placement



**Figure 4:** Example underdrain placement

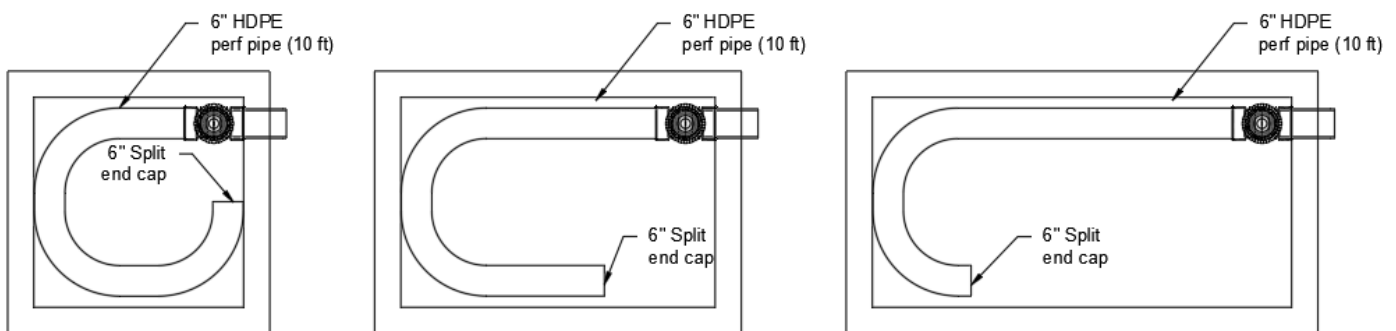
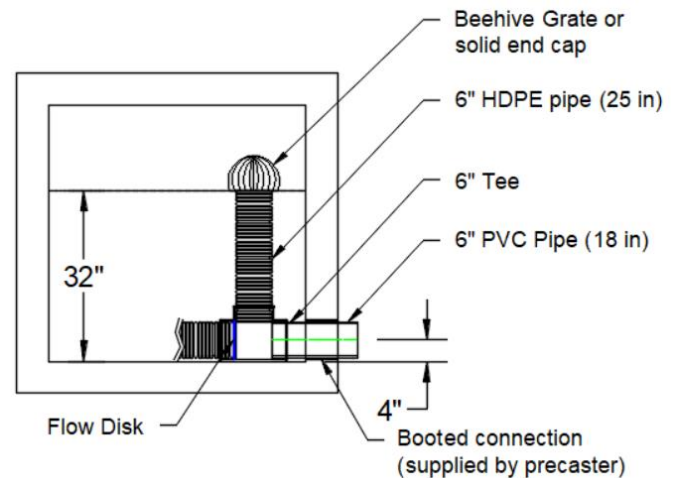

**Figure 5:** Underdrain configurations for EcoStream models using Underdrain Kit 1

2. Install the underdrain assembly (figure 5). See drawing detail for assembly components.
  - a. Install 18" (450 mm) long pipe through vault wall with booted connection (not supplied by ADS)
  - b. Attach 18" (450 mm) long pipe to 6" (150 mm) PVC tee.
  - c. Install flow disk into tee as shown in figure 3. Flow disk orifice is to be oriented such that the invert of the orifice invert matches the reducer/tee invert.
  - d. Install 25" (625 mm) standpipe (beehive grate will be supplied by ADS preinstalled on the standpipe).
    - i. If engineer's plans call for solid cap on the standpipe precaster will remove the beehive grate and install the 6" (150 mm) solid end cap.
  - e. Install 10' (3.0 m) of 6" (150 mm) perf pipe as shown in figure 5.
  - f. Attach 6" (150 mm) split end cap to end of underdrain pipe as shown in figure 5.
  
3. Add the No 57 washed stone over the underdrain assembly (approximately 7" (175 mm) to cover the underdrain crown).

## Underdrain Kit 2

1. Confirm the following pieces are in the Kit.
  - a. 6" (150 mm) PVC pipe 18" (450 mm) long (outlet pipe)
  - b. 6" (150 mm) Tee
  - c. 6" (150 mm) HDPE pipe 25" (625 mm) long (standpipe)
  - d. 6" (150 mm) Beehive Grate
  - e. 6" (150 mm) solid end cap (for standpipe if applicable)
  - f. 6" (150 mm) HDPE split end cap (for underdrain)
  - g. Flow Disk
  - h. 6" (150 mm) HDPE perf pipe (15' (4.6 m) min.)



**Figure 6:** Underdrain Kit 2 Assembly



**Figure 7:** Flow Disk Installation

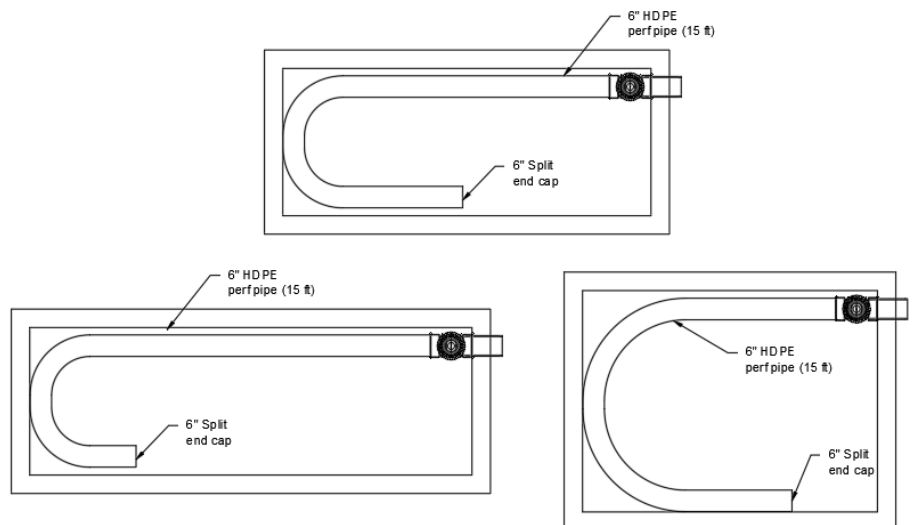
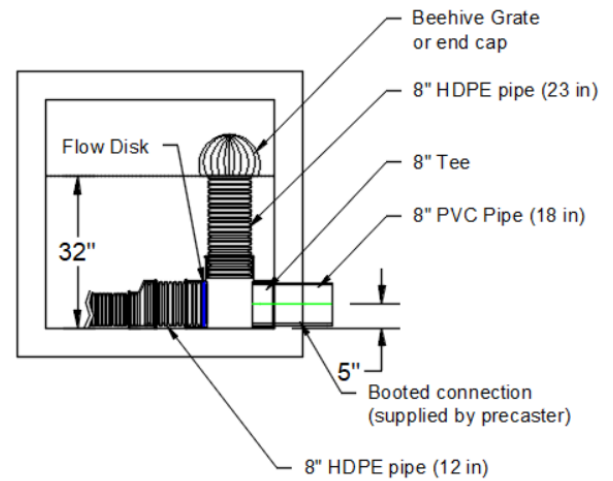

**Figure 8:** Underdrain configurations for EcoStream models using Underdrain Kit 2

2. Install the underdrain assembly (figure 8). See drawing detail for assembly components.
  - a. Install 18" (450 mm) long pipe through vault wall with booted connection (not supplied by ADS)
  - b. Attach 18" (450 mm) long pipe to 6" (150 mm) PVC tee
  - c. Install flow disk into tee as shown in figure 7, flow disk orifice is to be oriented such that the invert of the orifice invert matches the reducer/tee invert
  - d. Install 25" (625 mm) standpipe (beehive grate will be supplied by ADS preinstalled on the standpipe)
    - i. If engineer's plans call for solid cap on the standpipe precaster will remove the beehive grate and install the 6" (150 mm) solid end cap
  - e. Install 15' (4.6 m) of 6" (150 mm) perf pipe as shown in figure 8.
  - f. Attach 6" (150 mm) split end cap to end of underdrain pipe as shown in figure 8.
3. Add the No 57 washed stone over the underdrain assembly (approximately 7" [175 mm] to cover the underdrain crown).

### Underdrain Kit 3

1. Confirm the following pieces are in the Kit.
  - a. 8" (200 mm) PVC pipe 18" (450 mm) long (outlet pipe)
  - b. 8" (200 mm) Tee
  - c. 8" (200 mm) HDPE pipe 23" (575 mm) long (standpipe)
  - d. 8" (200 mm) Beehive Grate
  - e. 8" (200 mm) solid end cap (for standpipe if applicable)
  - f. 12" (300 mm) single wall HDPE
  - g. 6' x 8" (1.8 m x 200 mm) snap reducing coupler
  - h. 6" (150 mm) HDPE split end cap (for underdrain)
  - i. 6" (150 mm) HDPE perf pipe (25 ft min.)
  - j. Flow Disk



**Figure 9: Underdrain Kit 3 Assembly**



**Figure 10: Flow Disk Installation**

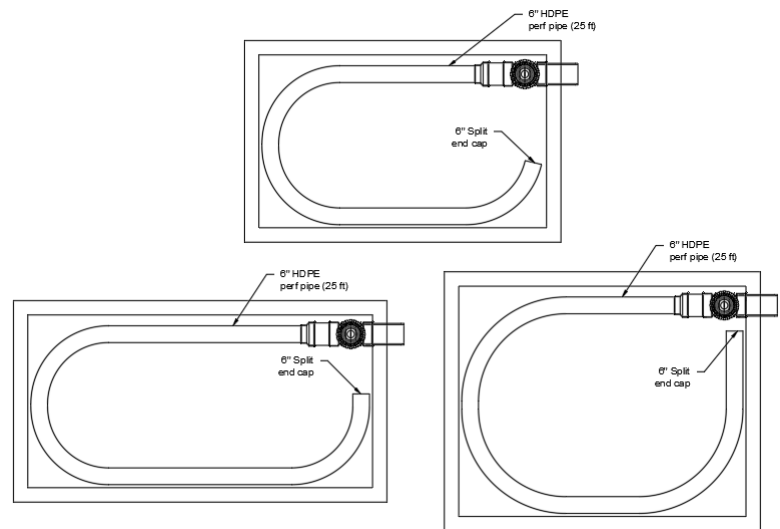

**Figure 11: underdrain configurations for EcoStream models using Underdrain Kit 3**

2. Install the underdrain assembly (figure 11). See drawing detail for assembly components.
  - a. Install 18" (450 mm) long pipe through vault wall with booted connection (not supplied by ADS)
  - b. Attach 18" (450 mm) long pipe to 8" (200 mm) tee.
  - c. Install flow disk into tee as shown in figure 10, flow disk orifice is to be oriented such that the invert of the orifice invert matches the reducer/tee invert
  - d. Install 23" (575 mm) standpipe (beehive grate will be supplied by ADS preinstalled on the standpipe)
    - a. If engineer's plans call for solid cap on the standpipe precaster will remove the beehive grate and install the 8" (400 mm) solid end cap.
  - e. Install 25' (7.6 m) of 6" (150 mm) perf pipe as shown in figure 11.
  - f. Attach 6" (150 mm) split end cap to end of underdrain pipe as shown in figure 11.
3. Add the No 57 washed stone over the underdrain assembly (approximately 7" (175 mm) to cover the underdrain crown).





- e. Install flow disk into tee as shown in figure 13, flow disk orifice is to be oriented such that the invert of the orifice invert matches the reducer/tee invert.
  - f. Install 12" (300 mm) of 10" (250 mm) HDPE pipe.
  - g. Attach 10" x 8" (250 x 200 mm) snap reducing coupler to 10" (250 mm) HDPE pipe.
  - h. Attach 12" (300 mm) of 8" (200 mm) HDPE pipe.
  - i. Attach 8" x 6" (200 x 150 mm) snap reducing coupler to the 8" (200 mm) HDPE pipe.
  - j. Install two runs of 20' (2.1 m) of 6" (150 mm) perf pipe as shown in figure 14, pipe to be field fit in the general configuration shown in the appropriate EcoStream unit.
  - k. Attach 6" (150 mm) split end cap to end of underdrain pipe as shown in figure 14.
3. Add the No 57 washed stone over the underdrain assembly (approximately 7" (175 mm) to cover the underdrain crown).

## Vault Installation – Site Contractor

1. Contact utility locator to mark any nearby underground utilities and make sure it is safe to excavate.
2. Reference the site plan and stake out the location of the EcoStream Biofilter vault.
3. Excavate the hole, providing any sheeting and shoring necessary to comply with all federal, state and local safety regulations.
4. Level the subgrade to the proper elevation. Verify the elevation against the EcoStream Biofilter vault dimensions, the invert elevations, and the site plans. Adjust the base aggregate, if necessary.
5. Have the soil bearing capacity verified by a licensed engineer for the required load bearing capacity. On solid subgrade, set the first section, or base section of the EcoStream Biofilter™ vault.

## EcoStream Media Installation - Contractor

1. The amount of full and half sacks required for the different size EcoStream vaults are shown in Table 1. The biofiltration media sacks weigh approximately 600 lbs (272.2 kg) and 1200 lbs (544.3 kg). The sack should be lifted over the cell and opened with the bag tie (located on the bottom) to release the media into the vault directly on top of the gravel bed placed during the underdrain installation step. When installing the media care is to be taken to ensure the standpipe stays seated in the tee fitting and media does not get inot the beehive/standpipe. All media bags supplied should be used and spread out evenly in the vault. This will create a 15" (375 mm) layer of EcoStream biofiltration media. A dusk mask is recommended when installing the EcoStream media. See SDS for more information.



**Figure 15:** Filtration media bag, installing filter media

2. Once the filtration media is placed, approximately 5 inches of growth media will be added to the system. This plant growth media or landscaping mulch shall be sourced by the contractor. Hand or minor excavator “raking” should be performed to create an even surface for the final install of plants if required per the engineer’s plans. Plant placement will depend on time of year and may not be performed going into a winter season at a given site.
3. Mulch - hardwood brown mulch (no dyes added) available at most home improvement centers.
4. If the engineer's plans call for a solid end cap on top of the standpipe, remove the preinstalled beehive grate and install the solid end cap.
5. With the inlet (if required) and outlet pipes set, partially backfill around the vault to within a few inches of the top of the vault or a few inches below the precast throated inlet.



**Figure 16:** Filtration media bag, installing filter

## Final Field Installation Steps – Site Contractor

1. Final backfill around the vault should be completed.
2. If a throated or curb inlet is to be set/poured, do this once the entire system is installed and they are running/pouring the curb and gutter line.
3. Place 4 to 6” (100 to 150 mm) sized rip rap at all throated or curb inlets and pipe inlets.
4. Place the final top slab on top of the unit and seal using standard concrete structure mastic.
5. The contractor/landscape architect will supply the plants. Install the planting using the EcoStream Plant Guide as a reference. Add additional mulch as needed to complete the planter cell and EcoStream system.

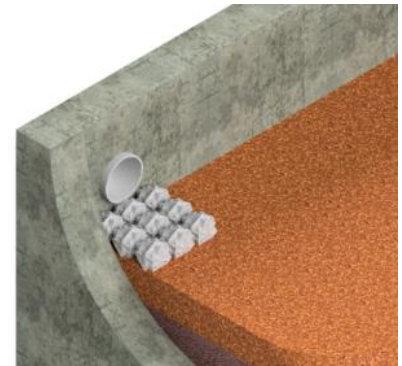

Call ADS at 800-821-6710 for further information or visit [www.adspipe.com](http://www.adspipe.com).

