

# Water Management Product Catalog

---



# Table of Contents

## Product Applications

Matrix of appropriate applications for pipe products 2-3

### Pipe

Pipe Descriptions & Specifications	4
High Performance Storm & Sanitary	5
Dual Wall	
• Storm Drainage	6-11
Single Wall	
• Characteristics	12
• Storm Drainage	13-15
• Co-Ex	15
• Channel Muck and Channel Flow	16
N-12® Flex Pipe and Grain-Aire® Pipe	17
Triplewall & SB2®	18

### ADS PolyFlex® Pressure Pipe

• Potable Copper Tube Size (CTS)	19
• SIDR IPS NSF Potable Grade	20
• SIDR IPS Standard Grade	21
• Utility Grade	22

### Fittings

• Dual Wall	23-35
• Nyloplast® Fittings	36-39
• Inserta Tee®	40-42
• Inserta Tee Hole Saws	43-44
• Single Wall	45-48
• Hickenbottom® & Precision Intake	49
• Specialty Fittings	50

### Nyloplast®

• Drain Basins	51
• Inline Drains	52
• Inspection Ports	53
• Curb Inlet Structures	54
• Road & Highway Structures	55
• Grates	56
• Risers, Sump Inserts & Add-A-Branch	57
• Weir Structures	58

## Retention/Detention Systems

• Land Max® Manifolds	59
• Manifold Bends	60
• Land Max Accessories	61-62
• StormTech® Chambers & End Caps	63
• StormTech Top & Bottom Inlets	64
• StormTech Bends	65
• StormTech Manifolds	66
• Aquabox	67
• Rainwater Harvesting	67

## Storm Water Treatment

• BioFilters	68
• Separators	69
• Water Quality Units	70
• FlexStorm® Inlet Filters	71-73

## Linear Drains

Duraslot® Slotted Drain	74-77
Duraslot XL Trench Drain	78-80

AdvanEdge® 81

Onsite Chambers 82-83

Septic Stack™ 83

Waste Water Accessories 84

Foundation Drainage & Accessories 85

## Geosynthetics

• Nonwovens	86-87
• Wovens	88
• Geogrids	89
• Paving Fabrics	89
• Silt Fence	89
• Erosion Control Blankets	90
• Turf Reinforcement Mats	90
• Ground Protection Mats	90
• Septic Fabrics	91



RESALE ITEMS – MARKED WITH  – ARE PRODUCTS OFFERED FOR SALE BUT NOT MANUFACTURED BY ADS.

STANDARD AND METRIC UNITS ARE PROVIDED ON PRODUCTS THROUGHOUT THE CATALOG. UNLESS STATED OTHERWISE, METRIC UNITS SHOULD BE USED FOR REFERENCE PURPOSES ONLY. PRODUCTS SUBJECT TO CHANGE WITHOUT NOTICE. ALL SALES OF OUR PRODUCT ARE SUBJECT TO A LIMITED WARRANTY AND PURCHASERS ARE SOLELY RESPONSIBLE FOR INSTALLATION AND USE OF OUR PRODUCTS AND DETERMINING WHETHER A PRODUCT IS SUITED FOR ANY SPECIFIC NEEDS. PLEASE CONSULT A FULL COPY OF TERMS AND CONDITIONS FOR SALE FOR FURTHER DETAILS.

# Product Applications

Product Type	Dual Wall						Triplewall
	High-Density Polyethylene (HDPE)					PP	PP
	N-12® WT	N-12 ST	N-12 Plain End	Mega Green®	N-12 Flex Dual Wall	HP Storm	SaniTite® HP
<b>Construction products</b>							
Storm sewer	•	•	•	•		•	
Retention/Detention	•	•	•	•		•	
Culverts/Cross drains	•	•	•	•		•	
Slope/Edge drains	•	•	•	•		•	
Mining/Forestry/Industrial	•	•	•	•		•	
Post tensioning							
<b>Residential products</b>							
Foundations/Edge drains	•	•	•	•			
Downspouts/Roof drainage	•	•	•	•			
Culverts	•	•	•	•		•	
Sub-drainage							
On-site waste management							
<b>Recreation products</b>							
Paths/Walkways/Edge drains	•	•	•	•			
Sports playing fields	•	•	•	•		•	
Culverts	•	•	•	•			
Parking lot drainage	•	•	•	•		•	
Golf course drainage		•	•	•			
Landscape/Sub drainage							
<b>Agriculture Products</b>							
Field drainage					•		
Grain aeration		•	•	•			
Land reclamation	•	•	•	•	•		
Terracing	•	•	•	•	•		
Ditch Enclosures	•	•	•	•	•	•	
<b>Sanitary Sewer/Industrial Products</b>							
Sanitary Sewer Lines							•
Industrial waste							•

Suggested products and applications are provided for general guidance only. Contact a sales representative to discuss the products acceptable for specific applications.

# Product Applications

	Singlewall						
	High-Density Polyethylene (HDPE)						
Product Type	Highway	Heavy Duty	Co-Ex	Channel Muck	Channel Flow	Gravel-less	Triplewall
<b>Construction products</b>							
Storm sewer							
Retention/Detention	•						
Culverts/Cross drains	•	•					
Slope/Edge drains	•	•					
Mining/Forestry/Industrial							
<b>Residential Products</b>							
Foundation/Edge drains		•					•
Downspouts/Roof drainage		•					•
Culverts	•	•					
Sub drainage		•					•
On-site waste management					•	•	•
<b>Recreation Products</b>							
Paths/Walkways/Edge drains		•					•
Sports playing fields	•	•					•
Culverts	•	•					
Parking lot drainage	•	•					
Golf course drainage	•	•					•
Landscape/Sub drainage	•	•					•
<b>Agriculture Products</b>							
Field drainage		•	•	•			
Grain aeration		•					
Land reclamation		•	•	•			
Waterways	•	•					
Terracing	•	•					
Ditch Enclosures	•	•					



# Pipe Descriptions, Specifications

## HP Storm, SaniTite HP & N-12 Dual Wall Pipe

### HP Storm (polypropylene)

Product	Description	Diameter	Connections	Specifications/Performance
HP Storm	Annular corrugations with smooth interior surface. Pipe is bell-and-spigot with the bell reinforced with a polymer wrap.	12"-60" (300-1500 mm) dual wall	Bell-and-spigot with a rubber gasket meeting ASTM D3212.	12"-60" (300-1500 mm) meets or exceeds ASTM F2881 and AASHTO M330.

### SaniTite HP (polypropylene)

Product	Description	Diameter	Connections	Specifications/Performance
SaniTite HP	Annular corrugations with smooth interior wall. 30"-60" (750-1500 mm) has smooth exterior surface. Pipe is bell-and-spigot. Bell reinforced with polymer wrap and spigot having two gaskets.	12"-30" (300-750 mm) dual wall  30"-60" (750-1500 mm) triple wall	Bell-and-spigot with two rubber gaskets meeting ASTM D3212.	12"-60" (300-1500 mm) meets ASTM F2764. 12"-60" (300-1500 mm) joints meet the requirements of ASTM F2764.

### N-12 (high-density polyethylene)

Product	Description	Diameter	Connections	Specifications/Performance
<b>N-12 Watertight (WT) IB</b>	Annular corrugations with smooth interior wall. Pipe is bell-and-spigot with a gasket for watertight connection.	4"-60" (100-1500 mm)	Bell-and-spigot with rubber gasket meeting ASTM F477.	4"-10" (100-250 mm) meets AASHTO M252 Type S. ** 12"-60" (300-1500 mm) meets ASTM F2306 & AASHTO M294, Type S. Joints meet the requirements of ASTM D3212. **
<b>N-12 Soil Tight (ST) IB</b>	Annular corrugations with smooth interior wall. Soil tight connection.	4"-30" (100-750 mm)	Bell-and-spigot with rubber gasket meeting ASTM F477.	4"-10" (100-250 mm) meets AASHTO M252 Type S. ** 12"-30" (300-750 mm) meets ASTM F2306 & AASHTO M294, Type S.
<b>N-12 Plain End</b>	Annular corrugations with smooth interior wall.	4"-60" (100-1500 mm)	External snap or split band couplers depending on diameter.	4"-10" (100-250 mm) meets AASHTO M252, Type S.** 12"-60" (300-1500 mm) meets AASHTO M294, Type S.**
<b>Mega Green Watertight (WT) IB</b>	Annular corrugations with smooth interior wall. Pipe is bell-and-spigot with a gasket for watertight connection.	4"-60" (100-1500 mm)	Bell-and-spigot with rubber gasket meeting ASTM F477.	4" - 60" (100-1500mm) meets ASTM F2648. Joints meet the requirement of ASTM D3212.
<b>Mega Green Soil Tight (ST) IB</b>	Annular corrugations with smooth interior wall. Soil tight connection.	4"-30" (100-750 mm)	Bell-and-spigot with rubber gasket meeting ASTM F477.	4" - 30" (100-750mm) meets ASTM F2648.

# High-Performance Pipe

## HP Storm & SaniTite HP Pipe

### HP Storm

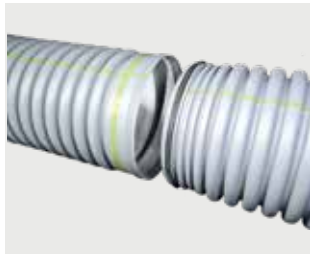

HP Storm

Diameter in (mm)	Length ft (m)	Product Code
12" (300)	20' (6.0)	12650020IBPL
15" (150)	20' (6.0)	15650020IBPL
18" (450)	20' (6.0)	18650020IBPL
24" (600)	20' (6.0)	24650020IBPL
30" (750)	20' (6.0)	30650020IBPL
36" (900)	20' (6.0)	36650020IBPL
42" (1050)	20' (6.0)	42650020IBPL
48" (1200)	20' (6.0)	48650020IBPL
60" (1500)	20' (6.0)	60650020IBPL

### SaniTite HP



Dual Wall SaniTite HP

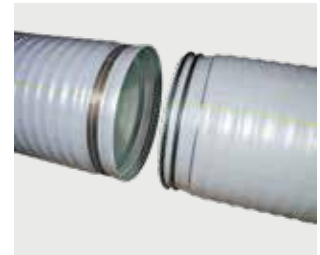

Triple Wall SaniTite HP

Diameter in (mm)	Length ft (m)	Style	Product Code
12" (300)	13' (4.0)	Dual wall	12300013IBPP
	20' (6.0)	Dual wall	12300020IBPP
15" (150)	13' (4.0)	Dual wall	15300013IBPP
	20' (6.0)	Dual wall	15300020IBPP
18" (450)	13' (4.0)	Dual wall	18300013IBPP
	20' (6.0)	Dual wall	18300020IBPP
24" (600)	13' (4.0)	Dual wall	24300013IBPP
	20' (6.0)	Dual wall	24300020IBPP
30" (750)	13' (4.0)	Dual wall	30300013IBPP
	20' (4.0)	Dual wall	30300020IBPP
30" (750)	13' (4.0)	Triple wall	30300013IBHP
	20' (6.0)	Triple wall	30300020IBHP
36" (900)	13' (4.0)	Triple wall	36300013IBHP
	20' (6.0)	Triple wall	36300020IBHP
42" (1050)	13' (4.0)	Triple wall	42300013IBHP
	20' (6.0)	Triple wall	42300020IBHP
48" (1200)	13' (4.0)	Triple wall	48300013IBHP
	20' (6.0)	Triple wall	48300020IBHP
60" (1500)	16.3' (4.9)	Triple wall	60300016.3IBHP
	20' (6.0)	Triple wall	60300020IBHP

\*LIMITED GEOGRAPHIC AVAILABILITY. PLEASE CHECK WITH SALES REPRESENTATIVE FOR AVAILABILITY.

# Dual Wall HDPE Pipe

4"-10" N-12 ST & N-12 WT per ASTM F2648

Diameter in (mm)	Length ft (m)	Style	N-12 ST	N-12 WT
4" (100)	10' (3)	Solid	04150010IBDW	
		Perf	04110010IBDW	
	20' (6)	Solid	04150020IBDW	04650020IBDW
		Perf	04110020IBDW	
		Sock	04230020IBDW	
6" (150)	20' (6)	Solid	06150020IBDW	06650020IBDW
		Perf	06110020IBDW	
		Sock	06230020IBDW	
8" (200)	20' (6)	Solid	08150020IBDW	08650020IBDW
		Perf	08110020IBDW	
		Sock	08230020IBDW	
10" (250)	10' (3)	Solid	10150010IBDW	
	20' (6)	Solid	10150020IBDW	10650020IBDW
		Perf	10110020IBDW	
		Sock	10230020IBDW	

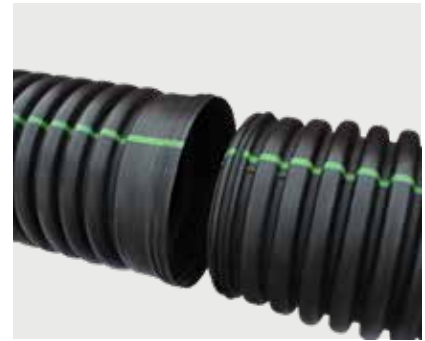

N-12 ST per ASTM



N-12 WT per ASTM

# Dual Wall HDPE Pipe

12"-60" N-12 ST & N-12 WT per ASTM F2648

Diameter in (mm)	Length ft (m)	Style	N-12 ST*	N-12 WT*
12" (300)	13' (4)	Solid	12850013DW	12650013DW
		Solid	12850020DW	12650020DW
	20' (6)	Perf	12810020DW	
		Sock	12830020DW	
15" (375)	13' (4)	Solid		15650013DW
		Solid	15850020DW	15650020DW
	20' (6)	Perf	15810020DW	
		Sock	15830020DW	
18" (450)	13' (4)	Solid	18850013DW	18650013DW
		Solid	18850020DW	18650020DW
	20' (6)	Perf	18810020DW	
		Sock	18830020DW	
24" (600)	13' (4)	Solid	24850013DW	24650013DW
		Solid	24850020DW	24650020DW
	20' (6)	Perf	24810020DW	
		Sock	24830020DW	
30" (750)	13' (4)	Solid	30850013DW	30650013DW
		Solid	30850020DW	30650020DW
	20' (6)	Perf	30810020DW	
		Sock	30830020DW	
36" (900)	13' (4)	Solid		36650013DW
		Solid		36650020DW
	20' (6)	Perf		36610020DW
		Sock		36630020DW
42" (1050)	13' (4)	Solid		42650013DW
		Solid		42650020DW
	20' (6)	Perf		42610020DW
48" (1200)	13' (4)	Solid		48650013DW
		Solid		48650020DW
	20' (6)	Perf		48610020DW
60" (1500)	20' (6)	Solid		60650020DW
	20' (6)	Perf		60610020DW



N-12 ST per ASTM



N-12 WT per ASTM

# Dual Wall HDPE Pipe

4"-10" N-12 Mega Green ST & WT per ASTM F2648

Diameter in (mm)	Length ft (m)	Style	N-12 ST	N-12 WT
4" (100)	10' (3)	Solid	04150010IBDW	
		Perf	04110010IBDW	
	20' (6)	Solid	04150020IBDW	04650020IBDW
		Perf	04110020IBDW	
		Sock	04230020IBDW	
6" (150)	20' (6)	Solid	06150020IBDW	06650020IBDW
		Perf	06110020IBDW	
		Sock	06230020IBDW	
8" (200)	20' (6)	Solid	08150020IBDW	08650020IBDW
		Perf	08110020IBDW	
		Sock	08230020IBDW	
10" (250)	10' (3)	Solid	10150010IBDW	
	20' (6)	Solid	10150020IBDW	10650020IBDW
		Perf	10110020IBDW	
		Sock	10230020IBDW	



N-12 ST



N-12 WT

# Dual Wall HDPE Pipe

12"-60" N-12 Mega Green ST & WT per ASTM F2648

Diameter in (mm)	Length ft (m)	Style	N-12 ST*	N-12 WT*
12" (300)	13' (4)	Solid	12850013DW	12650013DW
		Solid	12850020DW	12650020DW
	20' (6)	Perf	12810020DW	
		Sock	12830020DW	
15" (375)	13' (4)	Solid		15650013DW
		Solid	15850020DW	15650020DW
	20' (6)	Perf	15810020DW	
		Sock	15830020DW	
18" (450)	13' (4)	Solid	18850013DW	18650013DW
		Solid	18850020DW	18650020DW
	20' (6)	Perf	18810020DW	
		Sock	18830020DW	
24" (600)	13' (4)	Solid	24850013DW	24650013DW
		Solid	24850020DW	24650020DW
	20' (6)	Perf	24810020DW	
		Sock	24830020DW	
30" (750)	13' (4)	Solid	30850013DW	30650013DW
		Solid	30850020DW	30650020DW
	20' (6)	Perf	30810020DW	
		Sock	30830020DW	
36" (900)	13' (4)	Solid		36650013DW
		Solid		36650020DW
	20' (6)	Perf		36610020DW
		Sock		36630020DW
42" (1050)	13' (4)	Solid		42650013DW
		Solid		42650020DW
	20' (6)	Perf		42610020DW
48" (1200)	13' (4)	Solid		48650013DW
		Solid		48650020DW
	20' (6)	Perf		48610020DW
60" (1500)	20' (6)	Solid		60650020DW
	20' (6)	Perf		60610020DW



N-12 ST



N-12 WT

# Dual Wall HDPE Pipe

4"-10" N-12 Plain End, N-12 ST & N-12 WT per AASHTO M252

Diameter in (mm)	Length ft (m)	Style	N-12 Plain End	N-12 ST*	N-12 WT*
4" (100)	10' (3)	Solid	04150010	04150010IB	04650010IB
		Perf	04110010	04110010IB	
	20' (6)	Solid	04150020	04150020IB	04650020IB
		Perf	04110020	04110020IB	
		Sock	04230020	04230020IB	
	6" (150)	10' (3)	Solid	06150010	
Perf				06110010IB	
20' (6)		Solid	06150020	06150020IB	06650020IB
		Perf	06110020	06110020IB	
		Sock	06230020	06230020IB	
8" (200)		10' (3)	Solid	08150010	
	20' (6)	Solid	08150020	08150020IB	08650020IB
		Perf	08110020	08110020IB	
		Sock	08230020	08230020IB	
10" (250)	10' (3)	Solid	10150010		
	20' (6)	Solid	10150020	10150020IB	10650020IB
		Perf	10110020	10110020IB	
		Sock	10230020	10230020IB	

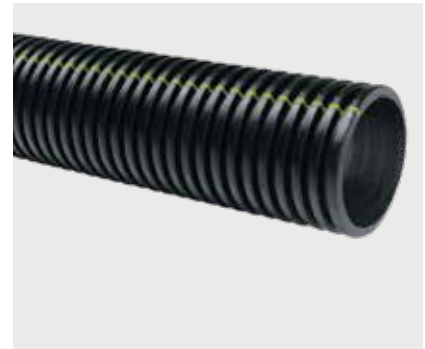

**N-12 Plain End per AASHTO**



**N-12 ST per ASTM**

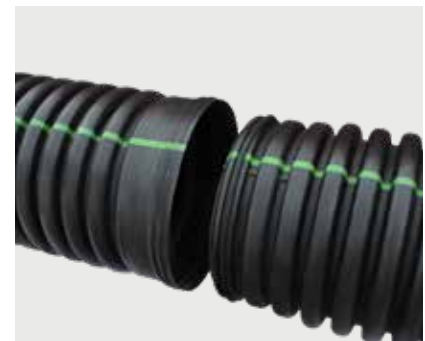

**N-12 WT per ASTM**

# Dual Wall HDPE Pipe

12"-60" N-12 Plain End, N-12 ST & N-12 WT per AASHTO M294

Diameter in (mm)	Length ft (m)	Style	N-12 Plain End	N-12 ST*	N-12 WT*
12" (300)	13' (4)	Solid		12850013IB	12650013IB
		Solid	12950020R	12850020IB	12650020IB
	20' (6)	Perf	12910020	12810020IB	
		Sock		12830020IB	
15" (375)	13' (4)	Solid		15850013IB	18650013IB
		Solid	15950020	15850020IB	15650020IB
	20' (6)	Perf	15910020	15810020IB	
		Sock	15930020	15830020IB	
18" (450)	13' (4)	Solid		18850013IB	18650013IB
		Solid	18950020	18850020IB	18650020IB
	20' (6)	Perf	18910020	18810020IB	
		Sock		18830020IB	
24" (600)	13' (4)	Solid		24850013IB	24650013IB
		Solid	24950020	24850020IB	24650020IB
	20' (6)	Perf	24910020	24810020IB	
		Sock		24830020IB	
30" (750)	13' (4)	Solid		30850013IB	30650013IB
	20' (6)	Solid	30950020	30850020IB	30650020IB
		Perf	30910020	30810020IB	
36" (900)	13' (4)	Solid			36650013IB
	20' (6)	Solid	36950020		36650020IB
		Perf	36910020		36610020IB
42" (1050)	13' (4)	Solid			42650013IB
	20' (6)	Solid	42950020		42650020IB
		Perf	42910020		42610020IB
48" (1200)	13' (4)	Solid			48650013IB
	20' (6)	Solid	48910020		48650020IB
		Perf	48910020		48610020IB
60" (1500)	13' (4)	Solid			60650013IB
	20' (6)	Solid	60950020		60650020IB
		Perf			60610020IB

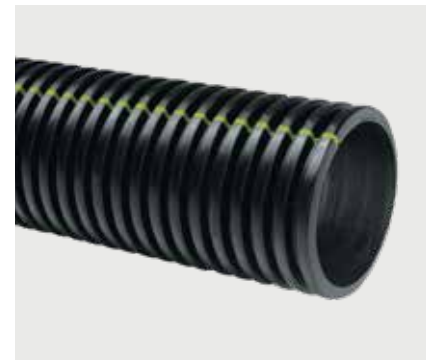

N-12 Plain End per AASHTO

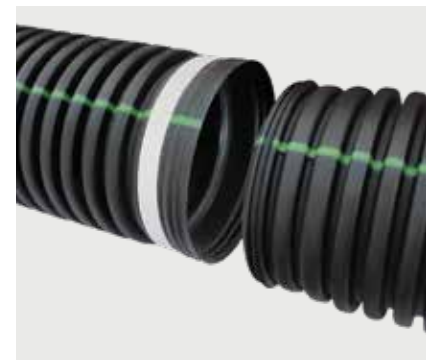

N-12 ST per AASHTO

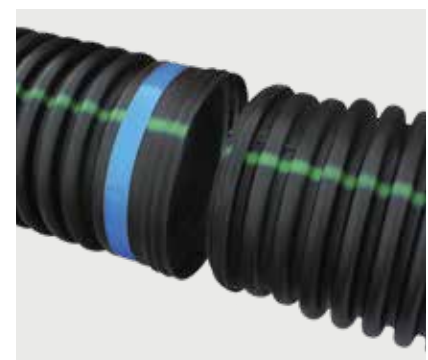

N-12 WT per AASHTO



# Single Wall HDPE Pipe

Product	Description	Diameter in (mm)	Length ft (m)	Connections	Specifications/ Performance in (mm)
<b>Highway Pipe</b>	Annular corrugated single wall.	4"-15" (100-375)	100'-3,200' (30-960 m) coils for 3"-6" (750-150) diameters. 20' (6) sticks for 8"-24" (200-600) diameters	Internal, external snap or split couplers.	4"-10" (100-250) meets AASHTO M252 Type C. 12"-15" (300-375 mm) meets AASHTO M294, Type C.
<b>Heavy Duty Pipe</b>	Annular corrugated single wall.	3"-15" (75-375)	100'-5,500' (30-1,676) coils depending on pipe diameter. 10'-20' (3-6) sticks depending on diameter.	Internal, external snap or split couplers.	Meets ASTM F667.
<b>Co-Ex</b>	Annular corrugated with white exterior and black interior.	4"-8" (100-200)	100'-3,200' (30-960) depending on diameter.	Internal, external snap or split couplers.	Meets ASTM F667.
<b>Channel Muck</b>	Annular corrugations with ¾" holes.	4" (100)	100'-3,200' (30-960)	Internal or external snap couplers.	Meets ASTM F667 & SCS 606.
<b>Channel Flow</b>	Annular corrugations with ¾" holes.	4" (100)	10'-250' (3-75)	Internal or external snap couplers.	Meets ASTM F667 & SCS 606.
<b>ADS 3000 Triple Wall Pipe</b>	Smooth white exterior and smooth black interior.	3" & 4" (75, 100)	10' (3)	Bell-and-spigot.	Meets ASTM F810.
<b>Grain-Aire® Pipe</b>	Annular corrugated single or dual wall pipe.	18"-24" (450-600)	20' (6)	Split band couplers.	Local/Manufacturer's recommendations.
<b>ADS PolyFlex</b>	Smooth exterior and interior polyethylene pressure pipe.	½"-2" (13-50)	100'-500' (30-152)	Internal and external couplers.	Meets ASTM D2239, AWWA C901 & NSF 14 & 61.

# Single Wall Pipe

4"-15" Highway

Inside Diameter in (mm)	Standard Length ft (m)	Style	Product Code
4" (100)	100' (30.5)	Solid	04400100
		Perf	04410100
	250' (76.2)	Solid	04400250
		Perf	04410250
		Perf/Wrap	04430250
	3,200' (975.4)	Solid	04403200
		Perf	04413200
6" (150)	100' (30.5)	Solid	06400100
		Perf	06410100
		Perf/Wrap	06430100
	1,500' (457.2)	Solid	06401500
		Perf	06411500
		Perf/Wrap	06431500
8" (200)	20' (6)	Solid	08400020
		Perf	08410020
		Perf/Wrap	08430020
10" (250)	20' (6)	Solid	10400020
		Perf	10410020
		Perf/Wrap	10430020
12" (300)	20' (6)	Solid	12400020
		Perf	12410020
		Perf/Wrap	12430020
15" (375)	20' (6)	Solid	15400020
		Perf	15410020



Solid wall coil



Perforated wall coil



Perforated with wrap wall coil

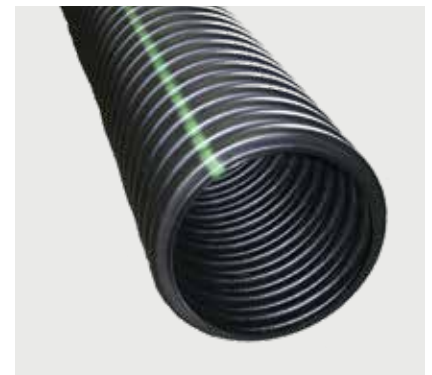

Solid stick

# Single Wall Pipe

3"-6" Regular & Heavy Duty

Inside Diameter in (mm)	Standard Length ft (m)	Style	Regular	Heavy Duty
3" (75)	10' (3)	Solid	03510010	
		Perf	03010010	
	100' (30.5)	Solid	03510100	03800100
		Perf	03010100	03810100
		Perf/Wrap	03730100BS	
		Fine Slot	03090100	
	300' (91.4)	Solid	03510300	
		Perf	03010300	
		Perf/Wrap	03730300BS	
	5,500' (1676.4)	Fine Slot		03090300
Perf			03815500	
		Fine Slot		03095500
4" (100)	10' (3)	Solid	04510010	
		Perf	04010010	
	50' (15.2)	Solid	04510050	
		Perf	04010050	
	100' (30.5)	Solid	04510100	04800100
		Perf	04010100	04810100
		Perf/Wrap	04730100BS	04830100BS
	250' (76.2)	Fine Slot		04090100
		Solid	04510250	04800250
		Perf	04010250	04810250
		Perf/Wrap	04730250BS	04830250BS
	3,200' (975.4)	Fine Slot		04090250
		Solid		04803200
		Perf		04813200
Perf/Wrap			04833200BS	
		Fine Slot		04093200
5" (125)	165' (50.2)	Solid	05510165	
		Perf	05010165	05810165
		Perf/Wrap		05830165BS
		Fine Slot		05090165
	2,000' (609.6)	Solid		05802000
		Perf		05812000
		Perf/Wrap		05832000BS
		Fine Slot		05092000
6" (150)	10' (3)	Solid	06510010	
		Perf	06010010	
	20' (6)	Solid	06510020	06800020
		Perf	06010020	06810020
	100' (30.5)	Solid	06510100	06800100
		Perf	06010100	06810100
		Perf/Wrap	06730100BS	06830100BS
	1,500' (457.2)	Fine Slot		06090100
		Solid		06801500
		Perf		06811500
Perf/Wrap			06831500BS	
		Fine Slot		06091500



Solid wall coil



Perforated wall coil



Perforated with sock coil

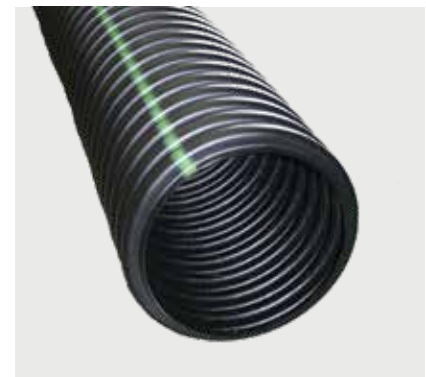

Solid stick

# Single Wall Pipe

## Heavy Duty, Co-Ex, Fine Slot

### 8"-15" Heavy Duty

Inside Diameter in (mm)	Standard Length ft (m)	Style	Regular	Heavy Duty
8" (200)	20' (6)	Solid	08510020	08800020
		Perf	08010020	08810020
		Perf/Wrap	08730020	08830020
	820 (249.9)	Solid		08800820
		Perf		08810820
		Perf/Wrap		08830820
		Fine Slot		08090820
10" (250)	20' (6)	Solid	10510020	10800020
		Perf	10010020	10810020
		Perf/Wrap	10730020	
	520' (158.5)	Solid		10800520
		Perf		10810520
		Perf/Wrap		10830520
		Fine Slot		10090520
12" (300)	20' (6)	Solid	12510020	
		Perf	12010020	
		Perf/Wrap	12730030	
	330' (100.5)	Solid	12510330	
		Perf	12010330	
		Perf/Wrap	12730330	
		Fine Slot		12090330
15" (375)	20' (6)	Solid	15510020	
		Perf	15010020	
	165' (50)	Solid	15510165	
		Perf	15010165	

### 4"-8" Co-Ex

Inside Diameter in (mm)	Standard Length ft (m)	Style	Product Code
4" (100)	100' (30.5)	Solid	04070100
		Perf	04080100
	250' (76.2)	Solid	04070250
		Perf	04080250
		Perf	04083200
6" (150)	100' (30.5)	Solid	06070100
		Perf	06080100
	1,500' (457.2)	Solid	06071500
		Perf	06081500
8" (200)	720' (219.4)	Solid	08070720
		Perf	08080720



Perforated wall coil

# Single Wall Pipe

## Channel Muck, Channel Flow

### 4" Channel Muck

Inside Diameter in (mm)	Standard Length ft (m)	Style	Product Code
4" (100)	100' (30.5)	Perf 3-Hole 360°	04060100
	250' (76.2)		04060250
	3,200' (975.4)		04063200
	250' (76.2)	Perf/Wrap	04770250BS
	3,200' (975.4)		04773200BS



### 4" Channel Flow

Inside Diameter in (mm)	Standard Length ft (m)	Style	Product Code
4" (100)	10' (3)	Perf 3-Hole 120°	04020010
	100' (30.5)		04020100
	250' (76.2)		04020250



### Accessories



Description	Lengths ft (m)	Product Code
2" (50 mm) Black Tape Roll	100' (30.5)	1137KA
½ (12.5) Black Filament Tape	100' (30.5)	1147KA



# HDPE Pipe

## N-12 Flex Dual Wall & Grain-Aire

### N-12 Flex Dual Wall

Diameter in (mm)	Length ft (m)	Style	Product Code
8" (200)	920' (280.4)	Solid	08950920
	920' (280.4)	Perf	08910920
	920' (280.4)	Fine Slot	08890920
10" (250)	550' (167.6)	Solid	10950550
	550' (167.6)	Fine Slot	10890550
12" (300)	360' (109.7)	Solid	12950360
	360' (109.7)	Perf	12910360
	360' (109.7)	Fine Slot	12890360
15" (375)	200' (61)	Solid	15950200I
	200' (61)	Perf	15910200I
	200' (61)	Fine Slot	15890200I



### 12"-36" Grain-Aire

Product	Diameter in (mm)	Length ft (m)	Product Code
Single Wall Pipe	12" (300)	20' (6)	12840020SW
Dual Wall Pipe	12" (300)	20' (6)	12840020
	18" (450)	20' (6)	18840020
Screen Fabric	24" (600)	20' (6)	24840020L
	18" (450)	300' (91.4)	1884HARL
Screen Fabric Sleeve	24" (600)	300' (91.4)	2484HARL
	12" (300)	21' (6.4)	1284HA
	18" (450)	21' (6.4)	1884HA
	24" (600)	21' (6.4)	2484HA
	30" (750)	21' (6.4)	3084HA
	36" (900)	21' (6.4)	3684HA

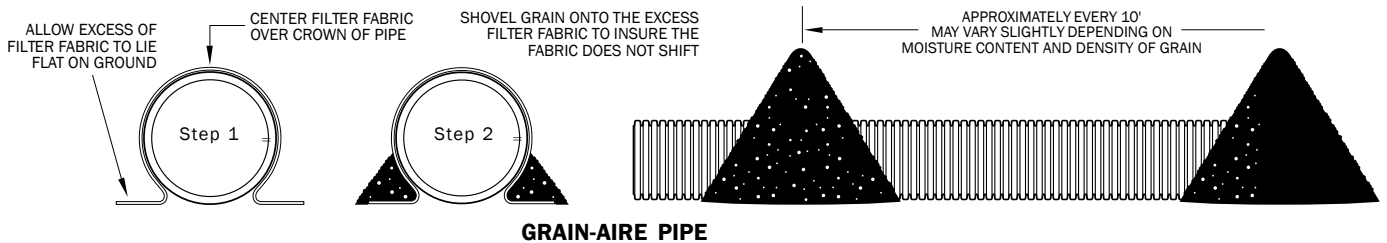

# HDPE Pipe

## Sewer & Drain Pipe

### 4" ADS 3000 Triplewall® Pipe

Inside Diameter in (mm)	Standard Length ft (m)	Style	Product Code
4" (100)	10' (3)	Plain	04550010
		2-hole	04520010
		3-hole	04530010

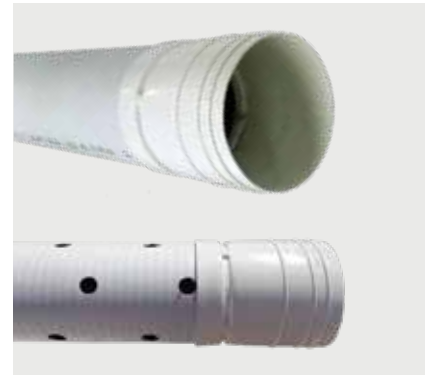

### 8"-10" SB2 Gravel-less Pipe

Inside Diameter in (mm)	Standard Length ft (m)	Style	Product Code
8" (200)	10' (3)	Perf/Cerex with Coupler	08710010WC
	20' (6)	Perf/Cerex with Coupler	08710020WC
		Perf/Sock	08710020WS
10" (250)	10' (3)	Perf/Sock with Coupler	10710010WSH
		Perf/Sock with Coupler	10710010WS
	20' (6)	Perf/Cerex	10710020
		Perf/Cerex with Coupler	10710020WC
		Perf/Sock Bundle Wrap	10710020WSBW
		Perf/Sock with Coupler	10710020WSH

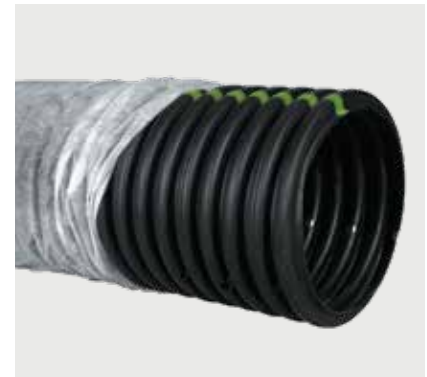



# Water Service Tubing

## ADS PolyFlex Copper Tube Size (CTS)

### SDR 9 250 psi (1724 kPA)\* PE 4710 (Blue)

Diameter in (mm)	Length ft (m)	Product Code
¾" (19)	100' (30.5)	X4-75250100
	200 (61.0)	X4-75250200
	300' (91.4)	X4-75250300
	500' (152.4)	X4-75250500
	1000' (304.8)	X4-752501000
1" (25)	100' (30.5)	X4-1250100
	200 (61.0)	X4-1250200
	300' (91.4)	X4-1250300
	500' (152.4)	X4-1250500
	1000' (304.8)	X4-12501000
1¼" (32)	100' (30.5)	X4-125250100
	200 (61.0)	X4-125250200
	300' (91.4)	X4-125250300
	500' (152.4)	X4-125250500
1½" (38)	100' (30.5)	X4-150250100
	200 (61.0)	X4-150250200
	300' (91.4)	X4-150250300
	500' (152.4)	X4-150250500
2" (50)	100' (30.5)	X4-2250100
	200 (61.0)	X4-2250200
	300' (91.4)	X4-2250300
	500' (152.4)	X4-2250500



### SDR 9 250 psi (1724 kPA)\* PE 4710 (Black)

Diameter in (mm)	Length ft (m)	Product Code
¾" (19)	100' (30.5)	X4-75250100B
	200 (61.0)	X4-75250200B
	300' (91.4)	X4-75250300B
	500' (152.4)	X4-75250500B
	1000' (304.8)	X4-752501000B
1" (25)	100' (30.5)	X4-1250100B
	200 (61.0)	X4-1250200B
	300' (91.4)	X4-1250300B
	500' (152.4)	X4-1250500B
	1000' (304.8)	X4-12501000B
1¼" (32)	100' (30.5)	X4-125250100B
	300' (91.4)	X4-125250300B
	500' (152.4)	X4-125250500B
1½" (38)	100' (30.5)	X4-150250100B
	200 (61.0)	X4-150250200B
	300' (91.4)	X4-150250300B
	165' (50.3)	X4-150250500B
2" (50)	100' (30.5)	X4-2250100B
	200 (61.0)	X4-2250200B
	300' (91.4)	X4-2250300B
	500' (152.4)	X4-2250500B



\*250 psi is maximum allowable pressure at 73° F (22.7° C)



# Potable Water Service Pipe

## ADS PolyFlex SIDR IPS NSF Potable Grade

### SIDR 9 200 psi (1379 kPa)\* PE 4710

Diameter in (mm)	Length ft (m)	Product Code
¾" (19)	100' (30.5)	X2-75200100
	300 (91.4)	X2-75200300
	400' (121.9)	X2-75200400
	500' (152.4)	X2-75200500
1" (25)	100' (30.5)	X2-1200100
	300' (91.4)	X2-1200300
	500' (152.4)	X2-1200500
	600' (182.8)	X2-1200500
1¼" (32)	100' (30.5)	X2-125200100
	300' (91.4)	X2-125200300
1½" (38)	100' (30.5)	X2-150200100
	300' (91.4)	X2-150200300
2" (50)	100' (30.5)	X2-2200100
	300' (91.4)	X2-2200300



### SIDR 7 250 psi (1724 kPa)\* PE 4710

Diameter in (mm)	Length ft (m)	Product Code
¾" (19)	100' (30.5)	X2-75250100
	300 (91.4)	X2-75250300
	500' (152.4)	X2-75250500
1" (25)	100' (30.5)	X2-1250100
	200' (61.0)	X2-1250200
	300' (91.4)	X2-1250300
	500' (152.4)	X2-1200500
1¼" (32)	100' (30.5)	X2-125250100
	300' (91.4)	X2-125250300
1½" (38)	100' (30.5)	X2-150250100
	300' (91.4)	X2-150250300
2" (50)	100' (30.5)	X2-2250100
	300' (91.4)	X2-2250300

\*Maximum allowable pressure at 73° F (22.7° C)

# Water Service Pipe

## ADS PolyFlex SIDR IPS Standard Grade

### SIDR 19 100 psi (690 kPa)\* PE 4710

Diameter in (mm)	Length ft (m)	Product Code
¾" (19)	100' (30.5)	X2-75100100
	300 (91.4)	X2-75100300
	400' (121.9)	X2-75100400
	500' (152.4)	X2-75100500
1" (25)	100' (30.5)	X2-1100100
	300' (91.4)	X2-1100300
	500' (152.4)	X2-1100500
1¼" (32)	100' (30.5)	X2-125100100
	300' (91.4)	X2-125100300
	500' (152.4)	X2-125100500
1½" (38)	100' (30.5)	X2-150100100
	300' (91.4)	X2-150100300
2" (50)	100' (30.5)	X2-2100100
	300' (91.4)	X2-2100300



### SIDR 15 125 psi (862 kPa)\* PE 4710

Diameter in (mm)	Length ft (m)	Product Code
½" (13)	100' (30.5)	X2-50125100
	300' (91.4)	X2-50125300
	400' (121.9)	X2-50125400
1" (25)	100' (30.5)	X2-1125100
	300' (91.4)	X2-1125300

### SIDR 11.5 160 psi (1103 kPa)\* PE 4710

Diameter in (mm)	Length ft (m)	Product Code
¾" (19)	100' (30.5)	X2-75160100
	300 (91.4)	X2-75160300
	400' (121.9)	X2-75160400
	500' (152.4)	X2-75160500
1" (25)	100' (30.5)	X2-1160100
	200' (61.0)	X2-1160200
	300' (91.4)	X2-1160300
	500' (152.4)	X2-1160500
1¼" (32)	100' (30.5)	X2-125160100
	300' (91.4)	X2-125160300
	500' (152.4)	X2-125160500
1½" (38)	100' (30.5)	X2-150160100
	300' (91.4)	X2-150160300
2" (50)	100' (30.5)	X2-2160100
	300' (91.4)	X2-2160300

\*Maximum allowable pressure at 73° F (22.7° C)

# Irrigation Service Pipe

## ADS PolyFlex Utility Grade

### 80 psi (551 kPa) Non-Potable

Diameter in (mm)	Length ft (m)	Product Code
¾" (19)	100' (30.5)	7580100
	300' (91.4)	7580300
1" (25)	100' (30.5)	180100
	300' (91.4)	180300
1¼" (32)	100' (30.5)	12580100
	300' (91.4)	12580300
1½" (38)	100' (30.5)	15080100
	300' (91.4)	15080300
2" (50)	100' (30.5)	280100
	300' (91.4)	280300



### 100 psi (689 kPa) Non-Potable

Diameter in (mm)	Length ft (m)	Product Code
¾" (19)	100' (30.5)	75100100
	300' (91.4)	75100300
1" (25)	100' (30.5)	1100100
	300' (91.4)	1100300
1¼" (32)	100' (30.5)	125100100
	300' (91.4)	125100300
1½" (38)	100' (30.5)	150100100
	300' (91.4)	150100300
2" (50)	100' (30.5)	2100100
	300' (91.4)	2100300

### 125 psi (862 kPa) Non-Potable

Diameter in (mm)	Length ft (m)	Product Code
½" (13)	100 (30.5)	50125100
	300 (91.4)	50125300

\*Maximum allowable pressure at 73° F (22.7° C)

# Dual Wall Fittings

## Couplers

### External Snap Coupler



Diameter in (mm)	Product Code
4" (100)	0412AA
6" (150)	0613AA
8" (200)	0813AA
10" (250)	1013AA

### Plain End Double Coupler



Diameter in (mm)	Product Code
10" (250)	1069AA
12" (300)	1269AA
15" (375)	1569AA
18" (450)	1869AA
24" (600)	2469AA
30" (750)	3069AA
36" (900)	3669AC

### Split Band Coupler



Diameter in (mm)	Product Code	
	Coupler	Coupler with Gasket
10" (250)	1011AA	1066AA
12" (300)	1265AA	1266AA
15" (375)	1565AA	1566AA
18" (450)	1865AA	1866AA
24" (600)	2465AA	2466AA
30" (750)	3065AA	3066AA
36" (900)	3661AA	3662AA
42" (1050)	4265AA	4266AA
48" (1200)	4865AA	4866AA
60" (1500)	6065AA	6066AA

### Bell-Bell Coupler



Diameter in (mm)	Product Code	
	N-12 ST	N-12 WT
12" (300)	1215AA	1215AA
15" (375)	1515AA	1515AA
18" (450)	1815AA	1815AA
24" (600)	2415AA	2415AA
30" (750)	3013AN65	3013AN65
36" (900)	3613AN65	3613AN65
42" (1050)	4213AN65	4213AN65
48" (1200)	4813AN65	4813AN65
60" (1500)	6013AN65	6013AN65

# Dual Wall Fittings

External Couplers & Internal Seals

## Mar Mac® Coupler



Diameter in (mm)	Product Code
8" (200)	0867RC
10" (250)	1067RC
12" (300)	1267RC
15" (375)	1567RC
18" (450)	1867RC
24" (600)	2467RC
30" (750)	3067RC
36" (900)	3667RC
42" (1050)	4267RC
48" (1200)	4867RC
60" (1500)	6067RC

## Mar Mac® Double Wide Coupler



Diameter in (mm)	Product Code
12" (300)	1267RCD
15" (375)	1567RCD
18" (450)	1867RCD
24" (600)	2467RCD
30" (750)	3067RCD
36" (900)	3667RCD
42" (1050)	4267RCD
48" (1200)	4867RCD
60" (1500)	6067RCD

## PVC Repair Sleeve\*



Diameter in (mm)	Product Code
4" (100)	0475AG
6" (150)	0675AG
8" (200)	0875AG
10" (250)	1075AG
12" (300)	1275AG
15" (375)	1575AG
18" (450)	1875AG
24" (600)	2475AG

\*Typically, two repair sleeves, gaskets, lube and a piece of pipe are needed for post-installation pipe repair.

NOTE: Contact your local sales representative for field repair of 30"-60" (750-1500 mm) diameter pipe and for availability of sizes not listed.

## NPC Internal Joint Seal



Diameter in (mm)	Width in (mm)	Product Code
18" (450)	10.5" (266)	1892NS
24" (600)	7.5" (190)	2491NS
	10.5" (266)	2492NS
30" (750)	7.5" (190)	3091NS
	10.5" (266)	3092NS
36" (900)	7.5" (190)	3691NS
	10.5" (266)	3692NS
42" (1050)	7.5" (190)	4291NS
	10.5" (266)	4292NS
48" (1200)	7.5" (190)	4891NS
	10.5" (266)	4892NS
60" (1500)	7.5" (190)	6091NS
	10.5" (266)	6092NS

# Dual Wall Fittings

End Caps, End Plugs & Lubricants

## End Caps\*



Diameter in (mm)	N-12 Plain End	N-12 WT Includes 1 gasket
12" (300)	1201AN	1201AN65B
15" (375)	1501AN	1501AN65B
18" (450)	1801AN	1801AN65B
24" (600)	2401AN	2401AN65B
30" (750)	3001AN	3001AN65B
36" (900)	3601AN	3601AN65B
42" (1050)	4201AN	4201AN65B
48" (1200)	4801AN	4801AN65B
60" (1500)	6001AN	6001AN65B

\*End caps are for horizontal applications only. End caps are not permitted to be used in any vertical applications. Misuse or failure to properly secure end caps may result in damage to persons or property or may result in injury or death.

## Non-Pressure Pipe End Plug with Gaskets\*



Diameter in (mm)	Product Code
8" (200)	0833AA
10" (250)	1033AA
12" (300)	1233AA
15" (375)	1533AA
18" (450)	1833AA
24" (600)	2433AA
30" (750)	3033AA
36" (900)	3633AA
42" (1050)	4233AA
48" (1200)	4833AA
60" (1500)	6033AA

## Snap End Caps\*\*



Diameter in (mm)	Product Code
6" (150)	0667AA
8" (200)	0867AA
10" (250)	1067AA

\*\* Not intended for permanent use or vertical orientation. NOTE: Contact your local sales representative for availability of sizes not listed above.

## N-12 Lubricants\*\*\*



Diameter in (mm)	Product Code 0200LU 1 quart (0.9 L)	Product Code 0800LU 1 gallon (3.8 L)
Typical Number of Joints Covered*		
4" (100)	89	356
6" (150)	61	244
8" (200)	43	172
10" (250)	33	132
12" (300)	25	100
15" (375)	20	80
18" (450)	16	64
24" (600)	10	40
30" (750)	9	36
36" (900)	7	28
42" (1050)	6	24
48" (1200)	6	24
60" (1500)	5	20

\*\*\*\* Based on joints with single gasket. Pipe with dual gaskets will require 75% more lube to cover the same number of joints.

# Dual Wall Fittings

## Fabricated Reducers

### Fabricated Reducers



**PLAIN END REDUCER**



**N-12 WT REDUCER**

Diameter in (mm)	N-12 Plain End	N-12 WT Includes 2 gaskets
6" x 4" (150 x 100)	0670AN	
8" x 4" (200 x 100)	0870AN	
8" x 6" (200 x 150)	0871AN	
10" x 4" (250 x 100)	1070AN	
10" x 6" (250 x 150)	1071AN	
10" x 8" (250 x 200)	1072AN	
12" x 4" (300 x 100)	1270AN	1270AN65B
12" x 6" (300 x 150)	1271AN	1271AN65B
12" x 8" (300 x 200)	1272AN	1272AN65B
12" x 10" (375 x 250)	1273AN	1273AN65B
15" x 4" (375 x 100)	1570AN	1570AN65B
15" x 6" (375 x 150)	1571AN	1571AN65B
15" x 8" (375 x 200)	1572AN	1572AN65B
15" x 10" (375 x 250)	1573AN	1573AN65B
15" x 12" (375 x 300)	1574AN	1574AN65B
18" x 4" (450 x 100)	1870AN	1870AN65B
18" x 6" (450 x 150)	1871AN	1871AN65B
18" x 8" (450 x 200)	1872AN	1872AN65B
18" x 10" (450 x 250)	1873AN	1873AN65B
18" x 12" (450 x 300)	1874AN	1874AN65B
18" x 15" (450 x 375)	1875AN	1875AN65B
24" x 4" (600 x 100)	2470AN	2470AN65B
24" x 6" (600 x 150)	2471AN	2471AN65B
24" x 8" (600 x 200)	2472AN	2472AN65B
24" x 10" (600 x 250)	2473AN	2473AN65B
24" x 12" (600 x 300)	2474AN	2474AN65B
24" x 15" (600 x 375)	2475AN	2474AN65B
24" x 18" (600 x 450)	2476AN	2476AN65B
30" x 4" (750 x 100)	3070AN	3070AN65B
30" x 6" (750 x 150)	3071AN	3071AN65B
30" x 8" (750 x 200)	3072AN	3072AN65B
30" x 10" (750 x 250)	3073AN	3073AN65B
30" x 12" (750 x 300)	3074AN	3074AN65B
30" x 15" (750 x 375)	3075AN	3075AN65B
30" x 18" (750 x 450)	3076AN	3076AN65B
30" x 24" (750 x 600)	3077AN	3077AN65B

Diameter in (mm)	N-12 Plain End	N-12 WT Includes 2 gaskets
36" x 4" (900 x 100)	3670AN	3670AN65B
36" x 6" (900 x 150)	3671AN	3671AN65B
36" x 8" (900 x 200)	3672AN	3672AN65B
36" x 10" (900 x 250)	3673AN	3673AN65B
36" x 12" (900 x 300)	3674AN	3674AN65B
36" x 15" (900 x 375)	3675AN	3675AN65B
36" x 18" (900 x 450)	3676AN	3676AN65B
36" x 24" (900 x 600)	3677AN	3677AN65B
36" x 30" (900 x 750)	3678AN	3678AN65B
42" x 6" (1050 x 150)	4271AN	4271AN65B
42" x 8" (1050 x 200)	4272AN	4272AN65B
42" x 10" (1050 x 250)	4273AN	4273AN65B
42" x 12" (1050 x 300)	4274AN	4274AN65B
42" x 15" (1050 x 375)	4275AN	4275AN65B
42" x 18" (1050 x 450)	4276AN	4276AN65B
42" x 24" (1050 x 600)	4277AN	4277AN65B
42" x 30" (1050 x 750)	4278AN	4278AN65B
42" x 36" (1050 x 900)	4279AN	4279AN65B
48" x 12" (1200 x 300)	4874AN	4874AN65B
48" x 15" (1200 x 375)	4875AN	4875AN65B
48" x 18" (1200 x 450)	4876AN	4876AN65B
48" x 24" (1200 x 600)	4877AN	4877AN65B
48" x 30" (1200 x 750)	4878AN	4878AN65B
48" x 36" (1200 x 900)	4879AN	4879AN65B
48" x 42" (1200 x 1050)	4842AN	4842AN65B
60" x 24" (1500 x 600)	6077AN	6077AN65B
60" x 30" (1500 x 750)	6078AN	6078AN65B
60" x 36" (1500 x 900)	6079AN	6079AN65B
60" x 42" (1500 x 1050)	6042AN	6042AN65B
60" x 48" (1500 x 1200)	6048AN	6048AN65B

NOTE: Contact your local sales representative for availability or sizes not listed above.

# Dual Wall Fittings

## Fabricated Tees & Reducing Tees

### Fabricated Tees



Plain End



N-12 WT

Diameter in (mm)	N-12 Plain End	N-12 WT Includes 3 gaskets
12" (300)	1264AN	1264AN65B
15" (375)	1565AN	1565AN65B
18" (450)	1866AN	1866AN65B
24" (600)	2467AN	2467AN65B
30" (750)	3068AN	3068AN65B
36" (900)	3669AN	3669AN65B
42" (1050)	4251AN	4251AN65B
48" (1200)	4851AN	4851AN65B
60" (1500)	6051AN	6051AN65B

### Cross Tees



Diameter in (mm)	N-12 Plain End
4" (100)	0430AN
6" (150)	0631AN
8" (200)	0832AN
10" (250)	1033AN
12" (300)	1234AN
15" (375)	1535AN
18" (450)	1836AN
24" (600)	2437AN

### Reducing Cross Tees



Diameter in (mm)	N-12 Plain End
6" x 4" (150 x 100)	0630AN
8" x 4" (200 x 100)	0830AN
8" x 6" (200 x 150)	0831AN
10" x 4" (250 x 100)	1030AN
10" x 6" (250 x 150)	1031AN
10" x 8" (250 x 200)	1032AN
12" x 4" (300 x 100)	1230AN
12" x 6" (300 x 150)	1231AN
12" x 8" (300 x 200)	1232AN
12" x 10" (375 x 250)	1233AN

### Reducing Tap Tees



Diameter in (mm)	N-12 WT Includes 2 gasket
6" x 4" (150 x 100)	0660AN65BS
8" x 4" (200 x 100)	0860AN65BS
10" x 6" (250 x 150)	1061AN65BS
12" x 4" (300 x 100)	1260AN65BS
12" x 6" (300 x 150)	1261AN65BS
18" x 4" (450 x 100)	1860AN65BS



# Dual Wall Fittings

## Fabricated Reducing Tees

### Fabricated Reducing Tees



Diameter in (mm)	N-12 Plain End	N-12 WT Includes 2 main and 1 stub gaskets
10" x 4" (250 x 100)	1060AN	
10" x 6" (250 x 150)	1061AN	
10" x 8" (250 x 200)	1062AN	
12" x 4" (300 x 100)	1260AN	1260AN65B
12" x 6" (300 x 150)	1261AN	1261AN65B
12" x 8" (300 x 200)	1262AN	1262AN65B
12" x 10" (375 x 250)	1263AN	1263AN65B
15" x 4" (375 x 100)	1560AN	1560AN65B
15" x 6" (375 x 150)	1561AN	1561AN65B
15" x 8" (375 x 200)	1562AN	1562AN65B
15" x 10" (375 x 250)	1563AN	1563AN65B
15" x 12" (375 x 300)	1564AN	1564AN65B
18" x 4" (450 x 100)	1860AN	1860AN65B
18" x 6" (450 x 150)	1861AN	1861AN65B
18" x 8" (450 x 200)	1862AN	1862AN65B
18" x 10" (450 x 250)	1863AN	1863AN65B
18" x 12" (450 x 300)	1864AN	1864AN65B
18" x 15" (450 x 375)	1865AN	1865AN65B
24" x 4" (600 x 100)	2460AN	2460AN65B
24" x 6" (600 x 150)	2461AN	2461AN65B
24" x 8" (600 x 200)	2462AN	2462AN65B
24" x 10" (600 x 250)	2463AN	2463AN65B
24" x 12" (600 x 300)	2464AN	2464AN65B
24" x 15" (600 x 375)	2465AN	2465AN65B
24" x 18" (600 x 450)	2466AN	2466AN65B
30" x 4" (750 x 100)	3060AN	3060AN65B
30" x 6" (750 x 150)	3061AN	3061AN65B
30" x 8" (750 x 200)	3062AN	3062AN65B
30" x 10" (750 x 250)	3063AN	3063AN65B
30" x 12" (750 x 300)	3064AN	3064AN65B
30" x 15" (750 x 375)	3065AN	3065AN65B
30" x 18" (750 x 450)	3066AN	3066AN65B
30" x 24" (750 x 600)	3067AN	3067AN65B
36" x 4" (900 x 100)	3660AN	3660AN65B
36" x 6" (900 x 150)	3661AN	3661AN65B
36" x 8" (900 x 200)	3662AN	3662AN65B
36" x 10" (900 x 250)	3663AN	3663AN65B

Diameter in (mm)	N-12 Plain End	N-12 WT Includes 2 main and 1 stub gaskets
36" x 12" (900 x 300)	3664AN	3664AN65B
36" x 15" (900 x 375)	3665AN	3665AN65B
36" x 18" (900 x 450)	3666AN	3666AN65B
36" x 24" (900 x 600)	3667AN	3667AN65B
36" x 30" (900 x 750)	3668AN	3668AN65B
42" x 4" (1050 x 100)	4260AN	4260AN65B
42" x 6" (1050 x 150)	4261AN	4261AN65B
42" x 8" (1050 x 200)	4262AN	4262AN65B
42" x 10" (1050 x 250)	4263AN	4263AN65B
42" x 12" (1050 x 300)	4264AN	4264AN65B
42" x 15" (1050 x 375)	4265AN	4265AN65B
42" x 18" (1050 x 450)	4266AN	4266AN65B
42" x 24" (1050 x 600)	4267AN	4267AN65B
42" x 30" (1050 x 750)	4268AN	4268AN65B
42" x 36" (1050 x 900)	4269AN	4269AN65B
48" x 4" (1200 x 100)	4860AN	4860AN65B
48" x 6" (1200 x 150)	4861AN	4861AN65B
48" x 8" (1200 x 200)	4862AN	4862AN65B
48" x 10" (1200 x 250)	4863AN	4863AN65B
48" x 12" (1200 x 300)	4864AN	4864AN65B
48" x 15" (1200 x 375)	4865AN	4865AN65B
48" x 18" (1200 x 450)	4866AN	4866AN65B
48" x 24" (1200 x 600)	4867AN	4867AN65B
48" x 30" (1200 x 750)	4868AN	4868AN65B
48" x 36" (1200 x 900)	4869AN	4869AN65B
48" x 42" (1200 x 1050)	4840AN	4840AN65B
60" x 4" (1500 x 100)	6060AN	6060AN65B
60" x 6" (1500 x 150)	6061AN	6061AN65B
60" x 8" (1500 x 200)	6062AN	6062AN65B
60" x 10" (1500 x 250)	6063AN	6063AN65B
60" x 12" (1500 x 300)	6064AN	6064AN65B
60" x 15" (1500 x 375)	6065AN	6065AN65B
60" x 18" (1500 x 450)	6066AN	6066AN65B
60" x 24" (1500 x 600)	6067AN	6067AN65B
60" x 30" (1500 x 750)	6068AN	6068AN65B
60" x 36" (1500 x 900)	6069AN	6069AN65B
60" x 42" (1500 x 1050)	6040AN	6040AN65B
60" x 48" (1500 x 1200)	6041AN	6041AN65B

# Dual Wall Fittings

## Fabricated Bends

### 11.25° Bend



Diameter in (mm)	N-12 Plain End	N-12 WT includes 2 gaskets
4" (100)	0491AN	
6" (150)	0691AN	
8" (200)	0891AN	
10" (250)	1091AN	
12" (300)	1291AN	1291AN65B
15" (375)	1591AN	1591AN65B
18" (450)	1891AN	1891AN65B
24" (600)	2491AN	2491AN65B
30" (750)	3091AN	3091AN65B
36" (900)	3691AN	3691AN65B
42" (1050)	4291AN	4291AN65B
48" (1200)	4891AN	4891AN65B
60" (1500)	6091AN	6091AN65B

### 30° Bend



Diameter in (mm)	N-12 Plain End	N-12 WT includes 2 gaskets
4" (100)	0495AN	
6" (150)	0695AN	
8" (200)	0895AN	
10" (250)	1095AN	
12" (300)	1295AN	1295AN65B
15" (375)	1595AN	1595AN65B
18" (450)	1895AN	1895AN65B
24" (600)	2495AN	2495AN65B
30" (750)	3095AN	3095AN65B
36" (900)	3695AN	3695AN65B
42" (1050)	4295AN	4295AN65B
48" (1200)	4895AN	4895AN65B
60" (1500)	6095AN	6095AN65B

### 22.5° Bend



Diameter in (mm)	N-12 Plain End	N-12 WT includes 2 gaskets
4" (100)	0492AN	
6" (150)	0692AN	
8" (200)	0892AN	
10" (250)	1092AN	
12" (300)	1292AN	1292AN65B
15" (375)	1592AN	1592AN65B
18" (450)	1892AN	1892AN65B
24" (600)	2492AN	2492AN65B
30" (750)	3092AN	3092AN65B
36" (900)	3692AN	3692AN65B
42" (1050)	4292AN	4292AN65B
48" (1200)	4892AN	4892AN65B
60" (1500)	6092AN	6092AN65B

### 45° Bend



Diameter in (mm)	N-12 Plain End	N-12 WT includes 2 gaskets
12" (300)	1297AN	1297AN65BB
15" (375)	1597AN	1597AN65BB
18" (450)	1897AN	1897AN65BB
24" (600)	2497AN	2497AN65BB
30" (750)	3097AN	3097AN65BB
36" (900)	3697AN	3697AN65BB
42" (1050)	4297AN	4297AN65BB
48" (1200)	4897AN	4897AN65BB
60" (1500)	6097AN	6097AN65BB

# Dual Wall Fittings

## Fabricated Bends

### 45° Mitered Bend



Diameter in (mm)	N-12 Plain End	N-12 WT includes 2 gaskets
12" (300)	1294AN	1294AN65B
15" (375)	1594AN	1594AN65B
18" (450)	1894AN	1894AN65B
24" (600)	2494AN	2494AN65B
30" (750)	3094AN	3094AN65B
36" (900)	3694AN	3694AN65B
42" (1050)	4294AN	4294AN65B
48" (1200)	4894AN	4894AN65B
60" (1500)	6094AN	6094AN65B

### 90° Bend



Diameter in (mm)	N-12 Plain End	N-12 WT includes 2 gaskets
4" (100)	0499AN	
6" (150)	0699AN	
8" (200)	0899AN	
10" (250)	1099AN	
12" (300)	1299AN	1299AN65B
15" (375)	1599AN	1599AN65B
18" (450)	1899AN	1899AN65B
24" (600)		2499AN65B

# Dual Wall Fittings

*Fabricated 45° Wyes*

## Fabricated 45° Wye



Diameter in (mm)	N-12 Plain End	N-12 WT Includes 3 gaskets
12" (300)	1284AN	1284AN65B
15" (375)	1585AN	1585AN65B
18" (450)	1886AN	1886AN65B
24" (600)	2487AN	2487AN65B

## Fabricated Reducing 45° Wye



Diameter in (mm)	N-12 Plain End	N-12 WT Includes 2 main and 1 stub gaskets
10" x 4" (250 x 100)	1080AN	
10" x 6" (250 x 150)	1081AN	
10" x 8" (250 x 200)	1082AN	
12" x 4" (300 x 100)	1280AN	1280AN65B
12" x 6" (300 x 150)	1281AN	1281AN65B
12" x 8" (300 x 200)	1282AN	1282AN65B
12" x 10" (300 x 250)	1283AN	1283AN65B
15" x 4" (375 x 100)	1580AN	1580AN65B
15" x 6" (375 x 150)	1581AN	1581AN65B
15" x 8" (375 x 200)	1582AN	1582AN65B
15" x 10" (375 x 250)	1583AN	1583AN65B
15" x 12" (375 x 300)	1584AN	1584AN65B
18" x 4" (450 x 100)	1880AN	1880AN65B
18" x 6" (450 x 150)	1881AN	1881AN65B
18" x 8" (450 x 200)	1882AN	1882AN65B
18" x 10" (450 x 250)	1883AN	1883AN65B
18" x 12" (450 x 300)	1884AN	1884AN65B
18" x 15" (450 x 375)	1885AN	1885AN65B

Diameter in (mm)	N-12 Plain End	N-12 WT Includes 2 main and 1 stub gaskets
24" x 4" (600 x 100)	2480AN	2480AN65B
24" x 6" (600 x 150)	2481AN	2481AN65B
24" x 8" (600 x 200)	2482AN	2482AN65B
24" x 10" (600 x 250)	2483AN	2483AN65B
24" x 12" (600 x 300)	2484AN	2484AN65B
24" x 15" (600 x 375)	2485AN	2485AN65B
24" x 18" (600 x 450)	2486AN	2486AN65B
30" x 4" (750 x 100)	3080AN	3080AN65B
30" x 6" (750 x 150)	3081AN	3081AN65B
30" x 8" (750 x 200)	3082AN	3082AN65B
30" x 10" (750 x 250)	3083AN	3083AN65B
30" x 12" (750 x 300)	3084AN	3084AN65B
30" x 15" (750 x 375)	3085AN	3085AN65B
36" x 4" (900 x 100)		3680AN65B
36" x 6" (900 x 150)	3681AN	3681AN65B
36" x 8" (900 x 200)	3682AN	3682AN65B
36" x 10" (900 x 250)	3683AN	3683AN65B
36" x 12" (900 x 300)	3684AN	3684AN65B
36" x 15" (900 x 375)	3685AN	3685AN65B
36" x 18" (900 x 450)	3686AN	3686AN65B
42" x 6" (1050 x 150)		4281AN65B
42" x 8" (1050 x 200)	4282AN	4282AN65B
42" x 10" (1050 x 250)		4283AN65B
42" x 12" (1050 x 300)	4284AN	4284AN65B
42" x 15" (1050 x 450)		4285AN65B
42" x 18" (1050 x 450)	4286AN	4286AN65B
48" x 6" (1200 x 150)		4881AN65B
48" x 8" (1200 x 200)	4882AN	4882AN65B
48" x 10" (1200 x 250)		4883AN65B
48" x 12" (1200 x 300)	4884AN	4884AN65B
48" x 15" (1200 x 375)	4885AN	4885AN65B
48" x 18" (1200 x 450)	4886AN	4886AN65B
48" x 24" (1200 x 600)	4887AN	4887AN65B
60" x 8" (1500 x 200)	6082AN	6082AN65B
60" x 10" (1500 x 250)	6083AN	6083AN65B
60" x 12" (1500 x 300)	6084AN	6084AN65B
60" x 15" (1500 x 375)	6085AN	6085AN65B
60" x 18" (1500 x 450)	6086ANL	6086AN65B

NOTE: Contact your local sales representative for availability or sizes not listed above.

# Dual Wall Injection Molded Fittings

## Soil-Tight Fittings (Cleated Bells)

### Bell/Bell Tee



Diameter in (mm)	Package Qty.	Product Code
4" (100)	5	0460ST
6" (150)	3	0661ST
8" (200)	1	0862ST
10" (250)	1	1063ST
12" (300)	1	1264ST

### Bell/Bell 45° Wye



Diameter in (mm)	Package Qty.	Product Code
4" (100)	5	0480ST
6" (150)	2	0681ST
8" (200)	1	0882ST
10" (250)	1	1083ST
12" (300)	1	1284ST

### Reducing Tee



Diameter in (mm)	Package Qty.	Product Code
6" x 4" (150 x 100)	5	0660ST
10" x 8" (250 x 200)	1	1062ST
12" x 8" (300 x 200)	1	1262ST

### 45° Reducing Wye



Diameter in (mm)	Package Qty.	Product Code
6" x 4" (150 x 100)	2	0680ST
8" x 4" (200 x 100)	1	0880ST
8" x 6" (200 x 150)	1	0881ST
10" x 8" (250 x 200)	1	1082ST

### Sweeping Tee



Diameter in (mm)	Package Qty.	Product Code
8" x 4" (200 x 100)	1	0863ST
8" x 6" (200 x 150)	1	0836ST
10" x 6" (250 x 150)	1	1036ST

### Bell/Bell 90° Elbow



Diameter in (mm)	Package Qty.	Product Code
4" (100)	10	0499ST
6" (150)	5	0699ST
8" (200)	3	0899ST
10" (250)	1	1099ST
12" (300)	1	1299ST

### Bell/Bell 45° Elbow



Diameter in (mm)	Package Qty.	Product Code
4" (100)	15	0494ST
6" (150)	6	0694ST
8" (200)	3	0894ST
10" (250)	1	1094ST
12" (300)	1	1294ST



# Dual Wall Injection Molded Fittings

*Watertight Fittings (includes F477 gaskets for attachment on pipe end)*

## Bell/Bell Tee



Diameter in (mm)	Package Qty.	Product Code
4" (100)	5	0460WT
6" (150)	3	0661WT
8" (200)	1	0862WT
10" (250)	1	1063WT
12" (300)	1	1264WT

## Bell/Bell 45° Wye



Diameter in (mm)	Package Qty.	Product Code
4" (100)	5	0480WT
6" (150)	2	0681WT
8" (200)	1	0882WT
10" (250)	1	1083WT
12" (300)	1	1284WT

## Reducing Tee



Diameter in (mm)	Package Qty.	Product Code
6" x 4" (150 x 100)	5	0660WT
10" x 8" (250 x 200)	1	1062WT
12" x 8" (300 x 200)	1	1262WT

## Reducing 45° Wye



Diameter in (mm)	Package Qty.	Product Code
6" x 4" (150 x 100)	2	0680WT
8" x 4" (200 x 100)	1	0880WT
8" x 6" (200 x 150)	1	0881WT
10" x 8" (250 x 200)	1	1082WT
12" x 6" (300 x 150)	1	1281WT
12" x 8" (300 x 200)	1	1282WT

## Sweeping Tee



Diameter in (mm)	Package Qty.	Product Code
8" x 4" (200 x 100)	1	0863WT
8" x 6" (200 x 150)	1	0836WT
10" x 6" (250 x 150)	1	1036WT
12" x 6" (300 x 150)	1	1236WT

## End Cap



Diameter in (mm)	Package Qty.	Product Code
4" (100)	12	0432WT
6" (150)	1	0632WT

# Dual Wall Injection Molded Fittings

Watertight Fittings (includes F477 gaskets for attachment on pipe end)

## Bell/Bell 45° Elbow



Diameter in (mm)	Package Qty.	Product Code
4" (100)	15	0494WT
6" (150)	6	0694WT
8" (200)	3	0894WT
10" (250)	1	1094WT
12" (300)	1	1294WT

## Bell/Bell Coupler



Diameter in (mm)	Package Qty.	Product Code
4" (100)	40	0413WT
6" (150)	10	0613WT
8" (200)	5	0813WT
10" (250)	5	1013WT

## Bell/Bell 90° Elbow



Diameter in (mm)	Package Qty.	Product Code
4" (100)	15	0499WT
6" (150)	5	0699WT
8" (200)	3	0899WT
10" (250)	1	1099WT
12" (300)	1	1299WT

## Bell/Bell Reducing Coupler



Diameter in (mm)	Package Qty.	Product Code
6" x 4" (150 x 100)	10	0614WT
8" x 4" (200 x 100)	10	0814WT
8" x 6" (200 x 150)	5	0816WT
10" x 8" (250 x 200)	1	1018WT
12" x 8" (300 x 200)	1	1218WT
12" x 10" (300 x 250)	1	1210WT

## Bell/Spigot Reducing Coupler



Diameter in (mm)	Package Qty.	Product Code
6" x 4" (150 x 100)	10	0674WT
8" x 4" (200 x 100)	10	0874WT
8" x 6" (200 x 150)	8	0876WT

# Dual Wall Injection Molded Fittings

## ST & WT Reducing Fitting Kits

### Soil Tight Tee

Diameter in (mm)	Tee	Consists of Reducer	N-12 ST bell & spigot
10" x 4" (250 x 100)	1062ST (10" x 8")	+ 0874WT (8" x 4")	1060ST
12" x 10" (300 x 250)	1264ST (12")	+ 1210WT (12" x 10")	1263ST <sup>1,2</sup>



### Watertight Tee

Diameter in (mm)	Tee	Consists of Reducer	N-12 ST bell & spigot
8" x 6" (200 x 150)	0862WT (8" x 6")	+ 0876WT (8" x 6")	0861WT
10" x 4" (250 x 100)	1062WT (10" x 8")	+ 0874WT (8" x 4")	1060WT
12" x 4" (300 x 100)	1264WT (12" x 8")	+ 0874WT (8" x 4")	1260WT
12" x 10" (300 x 250)	1264WT (12")	+ 1210WT (12" x 10")	1263WT <sup>1,2</sup>



### Soil Tight Wye

Diameter in (mm)	Tee	Consists of Reducer	N-12 ST bell & spigot
12" x 10" (300 x 250)	1284 ST (12")	+ 1210WT (12" x 10")	1283WT <sup>3</sup>



### Watertight Wye

Diameter in (mm)	Tee	Consists of Reducer	N-12 ST bell & spigot
10" x 4" (250 x 100)	1082WT (10" x 8")	+ 0874WT (8" x 4")	1080WT
10" x 6" (250 x 150)	1082WT (10" x 8")	+ 0876WT (8" x 6")	1081WT
12" x 4" (300 x 100)	1282WT (12" x 8")	+ 0874WT (8" x 4")	1280WT
12" x 10" (300 x 250)	1284WT (12")	+ 1210WT (12" x 10")	1283WT <sup>3</sup>



### Watertight Reducer

Diameter in (mm)	Tee	Consists of Reducer	N-12 ST bell & spigot
10" x 4" (250 x 100)	1018WT (10" x 8")	+ 0874WT (8" x 4")	1074WT
10" x 6" (250 x 150)	1018WT (10" x 8")	+ 0876WT (8" x 6")	1076WT
12" x 4" (300 x 100)	1218WT (12" x 8")	+ 0874WT (8" x 4")	1274WT
12" x 6" (300 x 150)	1218WT (12" x 8")	+ 1210WT (8" x 6")	1276WT



<sup>1</sup> Additional pipe stub not shipped with item number. Order this pipe separately.

<sup>2</sup> 12" x 10" Tee: order 1264 (WT or ST) 12" x 12" Tee, 1210WT 12" x 10" Bell/Bell Reducer, and approximately 15" of 12" diameter dual wall pipe to make the connection between the two bell ends.

<sup>3</sup> 12" x 10" Wye: order 1284 (WT or ST) 12" x 12" Wye, 1210WT 12" x 10" Bell/Bell Reducer, and approximately 15" of 12" diameter dual wall pipe to make the connection between the two bell ends.



# Nyloplast PVC Fittings

*Watertight Fittings*

## SWR Spigot Adapter



Diameter in (mm)	Product Code
4" (100)	0468AG
6" (150)	0668AG
8" (200)	0868AG
10" (250)	1068AG
12" (300)	1268AG
15" (375)	1568AG
18" (450)	1868AG
24" (600)	2468AG

## Sanded Manhole Adapters

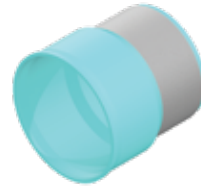

Diameter in (mm)	Product Code
4" (100)	0477AG
6" (150)	0677AG
8" (200)	0877AG
10" (250)	1077AG
12" (300)	1277AG
15" (375)	1577AG
18" (450)	1877AG
24" (600)	2477AG

## SWR Bell Adapter



Diameter in (mm)	Product Code
4" (100)	0469AG
6" (150)	0669AG
8" (200)	0869AG
10" (250)	1069AG
12" (300)	1269AG
15" (375)	1569AG
18" (450)	1869AG
24" (600)	2469AG

## Unsanded Manhole Adapters



Diameter in (mm)	Product Code
4" (100)	0477AGU
6" (150)	0677AGU
8" (200)	0877AGU
10" (250)	1077AGU
12" (300)	1277AGU
15" (375)	1577AGU
18" (450)	1877AGU
24" (600)	2477AGU

## Adapter with Sch 40 Spigot



Diameter in (mm)	Product Code
4" (100)	0478AG
6" (150)	0678AG
8" (200)	0878AG
10" (250)	1078AG
12" (300)	1278AG

## Adapter with Sch 40 Bell



Diameter in (mm)	Product Code
4" (100)	0479AG
6" (150)	0679AG
8" (200)	0879AG
10" (250)	1079AG
12" (300)	1279AG

# Nyloplast PVC Fittings

## Watertight Fittings

### Downspout Adapter

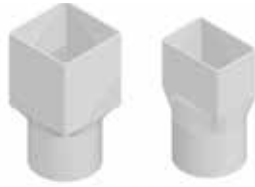

Diameter in (mm)	Product Code
4" x 4" x 4" (100 x 100 x 100)	0444FH
4" x 6" x 6" (100 x 150 x 150)	0466FH
6" x 6" x 6" (150 x 150 x 150)	0666FH
6" x 6" x 8" (150 x 150 x 200)	0668FH
8" x 8" x 8" (200 x 200 x 200)	0888FH

### N-12 Stop Coupling



Diameter in (mm)	Product Code
4" (100)	0471AG
6" (150)	0671AG
8" (200)	0871AG
10" (250)	1071AG
12" (300)	1271AG
15" (375)	1571AG
18" (450)	1871AG
24" (600)	2471AG

### Repair Coupling



Diameter in (mm)	Product Code
4" (100)	0475AG
6" (150)	0675AG
8" (200)	0875AG
10" (250)	1075AG
12" (300)	1275AG
15" (375)	1575AG
18" (450)	1875AG
24" (600)	2475AG

### End Cap



Diameter in (mm)	Product Code
4" (100)	0432AG
6" (150)	0632AG
8" (200)	0832AG
10" (250)	1032AG
12" (300)	1232AG
15" (375)	1532AG
18" (450)	1832AG
24" (600)	2432AG

### Clean Out



Diameter in (mm)	Product Code
4" (100)	0474AG
6" (150)	0674AG
8" (200)	0874AG
10" (250)	1074AG
12" (300)	1274AG

# Nyloplast PVC Fittings

## Watertight Fittings

### N-12 Bell x N-12 Bell Increaser



Diameter in (mm)	Product Code
6" x 4" (150 x 100)	0611AG
8" x 4" (200 x 100)	0811AG
8" x 6" (200 x 150)	0812AG
10" x 4" (250 x 100)	1011AG
10" x 6" (250 x 150)	1012AG
10" x 8" (250 x 200)	1013AG
12" x 4" (300 x 100)	1211AG
12" x 6" (300 x 150)	1213AG
15" x 4" (375 x 100)	1511AG
15" x 6" (375 x 150)	1512AG
15" x 8" (375 x 200)	1513AG
15" x 10" (375 x 250)	1514AG
15" x 12" (375 x 300)	1515AG
18" x 4" (450 x 100)	1811AG
18" x 6" (450 x 150)	1812AG
18" x 8" (450 x 200)	1813AG
18" x 10" (450 x 250)	1814AG
18" x 12" (450 x 300)	1815AG
18" x 15" (450 x 375)	1816AG
24" x 4" (600 x 100)	2411AG
24" x 6" (600 x 150)	2412AG
24" x 8" (600 x 200)	2413AG
24" x 10" (600 x 250)	2414AG
24" x 12" (600 x 300)	2415AG
24" x 15" (600 x 375)	2416AG
24" x 18" (600 x 450)	2417AG

### HP Stop Coupler



Diameter in (mm)	Product Code
12" (300)	1271AGHP
15" (375)	1571AGHP
18" (450)	1871AGHP
21" (525)	2171AGHP
24" (600)	2471AGHP
30" (750)	3071AGHP
36" (900)	3671AGHP

### HP Repair Coupler

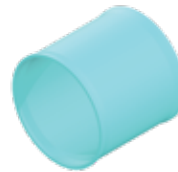

Diameter in (mm)	Product Code
12" (300)	1275AGHP
15" (375)	1575AGHP
18" (450)	1875AGHP
21" (525)	2175AGHP
24" (600)	2475AGHP
30" (750)	3075AGHP

### HP Bell x SWR Bell Adapter



Diameter in (mm)	Product Code
12" x 12" (300 x 300)	1269AGHP
15" x 15" (375 x 375)	1569AGHP
18" x 18" (450 x 450)	1869AGHP
24" x 24" (600 x 600)	2469AGHP

# Nyloplast PVC Fittings

## Watertight Fittings

### HP Bell x SWR Spigot Adapter\*



Diameter in (mm)	Product Code
12" x 12" (300 x 300)	1268AGHP
15" x 15" (375 x 375)	1568AGHP
18" x 18" (450 x 450)	1868AGHP
24" x 24" (600 x 600)	2468AGHP

### HP Unsanded Manhole Adapter\*\*



Diameter in (mm)	Product Code
12" (300)	1257AGHPU2
15" (375)	1557AGHPU2
18" (450)	1857AGHPU2
24" (600)	2457AGHPU2

### HP End Cap



Diameter in (mm)	Product Code
12" (300)	1232AGHP
15" (375)	1532AGHP
18" (450)	1832AGHP
24" (600)	2432AGHP
30" (750)	3032AGHP

### HP Sanded Manhole Adapter\*\*



Diameter in (mm)	Product Code
12" (300)	1257AGHP2
15" (375)	1557AGHP2
18" (450)	1857AGHP2
24" (600)	2457AGHP2

\* For pipe connection only

\*\*Two piece construction for steeper shoulder. Longer spigot length 24" (600 mm) fitting specifically for manhole connections

# Inserta Tee Fittings\*

## N-12

### N-12 into any Mainline Pipe\*\*

Diameter in (mm)	Product Code
4" into 6" (100 into 150)	4N126N12
4" into 8" (100 into 200)	4N128N12
4" into 10" (100 into 250)	4N1210-12FIT
4" into 12" (100 into 300)	4N1210-12FIT
4" into 15" (100 into 375)	4N1215+FIT
4" into 18" (100 into 450)	4N1215+FIT
4" into 24" (100 into 600)	4N1215+FIT
4" into 30" (100 into 750)	4N1215+FIT
4" into 36" (100 into 900)	4N1215+FIT
4" into 42" (100 into 1050)	4N1215+FIT
4" into 48" (100 into 1200)	4N1215+FIT
4" into 60" (100 into 1500)	4N1215+FIT
6" into 8" (150 into 200)	6N128N12
6" into 10" (150 into 250)	6N1210-12FIT
6" into 12" (150 into 300)	6N1210-12FIT
6" into 15" (150 into 375)	6N1215+FIT
6" into 18" (150 into 450)	6N1215+FIT
6" into 24" (150 into 600)	6N1215+FIT
6" into 30" (150 into 750)	6N1215+FIT
6" into 36" (150 into 900)	6N1215+FIT
6" into 42" (150 into 1050)	6N1215+FIT
6" into 48" (150 into 1200)	6N1215+FIT
6" into 60" (150 into 1500)	6N1215+FIT
8" into 12" (200 into 300)	8N1212-15FIT
8" into 15" (200 into 375)	8N1212-15FIT
8" into 18" (200 into 450)	8N1218+FIT
8" into 24" (200 into 450)	8N1218+FIT
8" into 30" (200 into 450)	8N1218+FIT
8" into 36" (200 into 450)	8N1218+FIT
8" into 42" (200 into 450)	8N1218+FIT
8" into 48" (200 into 450)	8N1218+FIT
8" into 60" (200 into 450)	8N1218+FIT

### N-12 into N-12

Diameter in (mm)	Product Code
10" into 15" (250 into 375)	10N1215N12
10" into 18" (250 into 450)	10N12MF18-24N12
10" into 24" (250 into 600)	10N12MF18-24N12
10" into 30" (250 into 750)	10N12MF30-60N12
10" into 36" (250 into 900)	10N12MF30-60N12
10" into 42" (250 into 1050)	10N12MF30-60N12
10" into 48" (250 into 1200)	10N12MF30-60N12
10" into 60" (250 into 1500)	10N12MF30-60N12
12" into 18" (300 into 450)	12N12MF18-24N12
12" into 24" (300 into 600)	12N12MF18-24N12
12" into 30" (300 into 750)	12N12MF30-60N12
12" into 36" (300 into 900)	12N12MF30-60N12
12" into 42" (300 into 1050)	12N12MF30-60N12
12" into 48" (300 into 1200)	12N12MF30-60N12
12" into 60" (300 into 1500)	12N12MF30-60N12
15" into 24" (375 into 600)	15N12MF24-60N12
15" into 30" (375 into 750)	15N12MF24-60N12
15" into 36" (375 into 900)	15N12MF24-60N12
15" into 42" (375 into 1050)	15N12MF24-60N12
15" into 48" (375 into 1200)	15N12MF24-60N12
15" into 60" (375 into 1500)	15N12MF24-60N12
18" into 30" (450 into 750)	18N12MF30-60N12
18" into 36" (450 into 900)	18N12MF30-60N12
18" into 42" (450 into 1050)	18N12MF30-60N12
18" into 48" (450 into 1200)	18N12MF30-60N12
18" into 60" (450 into 1500)	18N12MF30-60N12
24" into 36" (600 into 900)	24N12MF36-60N12
24" into 42" (600 into 1050)	24N12MF36-60N12
24" into 48" (600 into 1200)	24N12MF36-60N12
24" into 60" (600 into 1500)	24N12MF36-60N12

\*\* Parts with FIT in name indicate Inserta Tee OneFit. These parts can fit any mainline type.



\* Inserta Tee can be used in storm and sanitary sewer applications and can fit ANY mainline pipe type. Contact your ADS representative for assistance with part configurations for: Concrete, Clay, CMP, PVC, Fiberglass, CIPP, DIP, StormTech, Nyloplast structures, etc.

# Inserta Tee Fittings\*

SDR26/35

## SDR26/35 into any Mainline Pipe\*\*

Diameter in (mm)	Product Code
4" into 6" (100 into 150)	4P26FB6N12
4" into 8" (100 into 200)	4P26FB8N12
4" into 10" (100 into 250)	4P2610-12FIT
4" into 12" (100 into 300)	4P2610-12FIT
4" into 15" (100 into 375)	4P2615+FIT
4" into 18" (100 into 450)	4P2615+FIT
4" into 24" (100 into 600)	4P2615+FIT
4" into 30" (100 into 750)	4P2615+FIT
4" into 36" (100 into 900)	4P2615+FIT
4" into 42" (100 into 1050)	4P2615+FIT
4" into 48" (100 into 1200)	4P2615+FIT
4" into 60" (100 into 1500)	4P2615+FIT
6" into 8" (150 into 200)	6P26FB8N12
6" into 10" (150 into 250)	6P2610-12FIT
6" into 12" (150 into 300)	6P2610-12FIT
6" into 15" (150 into 375)	6P2615+FIT
6" into 18" (150 into 450)	6P2615+FIT
6" into 24" (150 into 600)	6P2615+FIT
6" into 30" (150 into 750)	6P2615+FIT
6" into 36" (150 into 900)	6P2615+FIT
6" into 42" (150 into 1050)	6P2615+FIT
6" into 48" (150 into 1200)	6P2615+FIT
6" into 60" (150 into 1500)	6P2615+FIT

\*\*SDR26 PVC Hub Options are Available from 4"-15" (100-375 mm)

## SDR35 into N-12

Diameter in (mm)	Product Code
10" into 15" (250 into 375)	10P3515N12
10" into 18" (250 into 450)	10P35MF18-24N12
10" into 24" (250 into 600)	10P35MF18-24N12
10" into 30" (250 into 750)	10P35MF30-60N12
10" into 36" (250 into 900)	10P35MF30-60N12
10" into 42" (250 into 1050)	10P35MF30-60N12
10" into 48" (250 into 1200)	10P35MF30-60N12
10" into 60" (250 into 1500)	10P35MF30-60N12
12" into 18" (300 into 450)	12P35MF18-24N12
12" into 24" (300 into 600)	12P35MF18-24N12
12" into 30" (300 into 750)	12P35MF30-60N12
12" into 36" (300 into 900)	12P35MF30-60N12
12" into 42" (300 into 1050)	12P35MF30-60N12
12" into 48" (300 into 1200)	12P35MF30-60N12
12" into 60" (300 into 1500)	12P35MF30-60N12
15" into 24" (375 into 600)	15P35MF24-60N12
15" into 30" (375 into 750)	15P35MF24-60N12
15" into 36" (375 into 900)	15P35MF24-60N12
15" into 42" (375 into 1050)	15P35MF24-60N12
15" into 48" (375 into 1200)	15P35MF24-60N12
15" into 60" (375 into 1500)	15P35MF24-60N12
18" into 30" (450 into 750)	18P35MF30-60N12
18" into 36" (450 into 900)	18P35MF30-60N12
18" into 42" (450 into 1050)	18P35MF30-60N12
18" into 48" (450 into 1200)	18P35MF30-60N12
18" into 60" (450 into 1500)	18P35MF30-60N12

## SDR35 into any Mainline Pipe

Diameter in (mm)	Product Code
8" into 12" (200 into 300)	8P3512-15FIT
8" into 15" (200 into 375)	8P3512-15FIT
8" into 18" (200 into 450)	8P3518+FIT
8" into 24" (200 into 450)	8P3518+FIT
8" into 30" (200 into 450)	8P3518+FIT
8" into 36" (200 into 450)	8P3518+FIT
8" into 42" (200 into 450)	8P3518+FIT
8" into 48" (200 into 450)	8P3518+FIT
8" into 60" (200 into 450)	8P3518+FIT

\* Inserta Tee can be used in storm and sanitary sewer applications and can fit ANY mainline pipe type.

\*\* SDR35 PVC is typical for storm applications. SDR26 PVC is typical for sanitary applications. For assistance with 8"-15" (200-375 mm) SDR26 PVC applications please contact your ADS sales representative for more information.

# Inserta Tee Fittings\*

IPS/SCH40 PVC

## IPS/SCH40 into any Mainline Pipe

Diameter in (mm)	Product Code
4" into 6" (100 into 150)	4IPS6N12
4" into 8" (100 into 200)	4IPS8N12
4" into 10" (100 into 250)	4IPS10-12FIT
4" into 12" (100 into 300)	4IPS10-12FIT
4" into 15" (100 into 375)	4IPS15+FIT
4" into 18" (100 into 450)	4IPS15+FIT
4" into 24" (100 into 600)	4IPS15+FIT
4" into 30" (100 into 750)	4IPS15+FIT
4" into 36" (100 into 900)	4IPS15+FIT
4" into 42" (100 into 1050)	4IPS15+FIT
4" into 48" (100 into 1200)	4IPS15+FIT
4" into 60" (100 into 1500)	4IPS15+FIT
6" into 8" (150- into 200)	6IPS8N12
6" into 10" (150 into 250)	6IPS10-12FIT
6" into 12" (150 into 300)	6IPS10-12FIT
6" into 15" (150 into 375)	6IPS15+FIT
6" into 18" (150 into 450)	6IPS15+FIT
6" into 24" (150 into 600)	6IPS15+FIT
6" into 30" (150 into 750)	6IPS15+FIT
6" into 36" (150 into 900)	6IPS15+FIT
6" into 42" (150 into 1050)	6IPS15+FIT
6" into 48" (150 into 1200)	6IPS15+FIT
6" into 60" (150 into 1500)	6IPS15+FIT
8" into 12" (200 into 300)	8IPS12-15FIT
8" into 15" (200 into 375)	8IPS12-15FIT
8" into 18" (200 into 450)	8IPS18+FIT
8" into 24" (200 into 450)	8IPS18+FIT
8" into 30" (200 into 450)	8IPS18+FIT
8" into 36" (200 into 450)	8IPS18+FIT
8" into 42" (200 into 450)	8IPS18+FIT
8" into 48" (200 into 450)	8IPS18+FIT
8" into 60" (200 into 450)	8IPS18+FIT

## IPS/SCH40 into N-12

Diameter in (mm)	Product Code
10" into 15" (250 into 375)	10IPS15N12
10" into 18" (250 into 450)	10IPSMF18-24N12
10" into 24" (250 into 600)	10IPSMF18-24N12
10" into 30" (250 into 750)	10IPSMF30-60N12
10" into 36" (250 into 900)	10IPSMF30-60N12
10" into 42" (250 into 1050)	10IPSMF30-60N12
10" into 48" (250 into 1200)	10IPSMF30-60N12
10" into 60" (250 into 1500)	10IPSMF30-60N12
12" into 18" (300 into 450)	12IPSMF18-24N12
12" into 24" (300 into 600)	12IPSMF18-24N12
12" into 30" (300 into 750)	12IPSMF30-60N12
12" into 36" (300 into 900)	12IPSMF30-60N12
12" into 42" (300 into 1050)	12IPSMF30-60N12
12" into 48" (300 into 1200)	12IPSMF30-60N12
12" into 60" (300 into 1500)	12IPSMF30-60N12

**C900/Ductile Iron Hub Options are Available from 4"-12" (100-300 mm).**

\* Inserta Tee can be used in storm and sanitary sewer applications and can fit ANY mainline pipe type. Contact your ADS representative for assistance with part configurations for: Concrete, Clay, CMP, PVC, Fiberglass, CIPP, DIP, StormTech, Nyloplast structures, etc.

# Inserta Tee

Hole Saws for Coring into Plastic Pipe\*

## Red Series for All Plastic Mainlines



Size in (mm)	Pilot Drill	Weight pounds	Product Code
4½" (114)	12 mm	3 (1.4)	R412SAW
6½" (165)	12 mm	4 (1.8)	R612SAW
8¾" (222)	12 mm	6 (2.7)	R834SAW

## Grey Series (Carbide Tipped) for Solid Wall HDPE Mainline



Size in (mm)	Pilot Drill	Weight pounds	Product Code
4½" (114)	¾"	6 (2.7)	PE412SAW
6½" (165)	¾"	9 (4.0)	PE612SAW
8¾" (222)	¾"	9 (4.0)	PE834SAW

## Blue Series for All Plastic Mainlines



Size in (mm)	Pilot Drill	Weight pounds	Product Code
2⅝" (67)	12 mm	2 (0.9)	BL258SAW
3¾" (95)	12 mm	3 (1.4)	BL334SAW
4½" (114)	12 mm	3 (1.4)	BL412SAW
6½" (165)	12 mm	4 (1.8)	BL612SAW
8¾" (222)	12 mm	6 (2.7)	BL834SAW
10⅞" (276)	¾"	12 (5.4)	BL1078SAW
12⅞" (327)	¾"	15 (6.8)	BL1278SAW
15 <sup>13</sup> / <sub>16</sub> " (402)	¾"	21 (9.5)	BL151316SAW
19 <sup>3</sup> / <sub>16</sub> " (487)	¾"	35 (15.9)	BL19316SAW
25 <sup>5</sup> / <sub>16</sub> " (643)	¾"	45 (20.4)	BL25516SAW

## Orange Series (For SaniTite HP Pipe Only)\*



Size in (mm)	Pilot Drill	Weight pounds	Product Code
4⅜"	12 mm	3 (1.4)	HP438SAW
6⅜"	12 mm	4 (1.8)	HP638SAW
8⅝"	12 mm	6 (2.7)	HP858SAW
10¾" (276)	¾"	12 (5.4)	HP1034SAW
12¾" (327)	¾"	15 (6.8)	HP1234SAW
15¾" (402)	¾"	21 (9.5)	HP1534SAW
19 <sup>1</sup> / <sub>16</sub> " (487)	¾"	35 (15.9)	HP19116SAW

\* For air-testable application only

\* When quoting hole saws, a ratio of one (1) saw for every 25 cuts is recommended.



# Inserta Tee

*Hole Saws for Coring Non-Plastic Pipe\**

## Gold Series (Use with Heavy Duty ½" Drill Motor)



Size in (mm)	Pilot Drill	Weight pounds	Product Code
2½" (67)	¾"	3 (1.4)	GA258BIT
3¾" (95)	¾"	10 (4.5)	GA334BIT
4½" (114)	¾"	12 (5.4)	GA412BIT
6½" (165)	¾"	18 (8.1)	GA612BIT
8¾" (222)	¾"	24 (10.9)	GA834BIT
10⅞" (276)	¾"	33 (15.0)	GA1078BIT

## Silver Series (Use with Heavy Duty ½" Drill Motor)



Size in (mm)	Pilot Drill	Weight pounds	Product Code
4½" (114)	10 mm	4 (1.8)	S412BIT
6½" (165)	10 mm	8 (3.6)	S612BIT
8¾" (222)	10 mm	13 (5.9)	S834BIT

## Gold Series (Use with Coring Machine)\*\*



Size in (mm)	Pilot Drill	Weight pounds	Product Code
4½"	¾"	9 (4.0)	G412BIT
6½"	¾"	15 (6.8)	G612BIT
8¾"	¾"	21 (9.5)	G834BIT
10⅞" (276)	¾"	30 (13.6)	G1078BIT
12⅞" (327)	¾"	41 (18.6)	G1278BIT
15 <sup>13</sup> / <sub>16</sub> " (402)	¾"	59 (26.8)	G151316BIT
19 <sup>3</sup> / <sub>16</sub> " (487)	¾"	62 (28.1)	G19316BIT
25 <sup>5</sup> / <sub>16</sub> " (643)	¾"	65 (29.5)	G25516BIT

\*\* Hole saws for coring machines are equipped with a 1¼" (31.75 mm) x 7 (thread) female adapter nut.

\* When quoting hole saws, a ratio of one (1) saw for every 10 cuts is recommended.

# Singlewall Fittings

## Couplers

### Internal Coupler



0315AA, 0417AA, 0615AA 0517AA, 0815AA, 1015AA

Diameter in (mm)	Package Qty.	Product Code
3" (75)	50	0315AA
4" (100)	16	0417AA
5" (125)	12	0517AA
6" (150)	9	0615AA
8" (200)	4	0815AA
10" (250)	4	1015AA

### Internal Reducing Coupler



Diameter in (mm)	Package Qty.	Product Code
5" x 4" (125 x 100)	16	0425AA
6" x 5" (150 x 125)	9	0526AA

### Snap Reducing Coupler



Diameter-Main x Stub in (mm)	Package Qty.	Product Code
4" x 3" (100 x 75)	24	0314AA
5" x 4" (125 x 100)	20	0514AA
6" x 4" (150 x 100)	9	0614AA
6" x 5" (150 x 125)	9	0516AA
8" x 6" (200 x 150)	9	0816AA
10" x 8" (250 x 200)	6	1018AA
12" x 10" (300 x 250)	1	1210AA
15" x 12" (375 x 300)	1	1512AA

### External Snap Coupler



Diameter in (mm)	Package Qty.	Product Code
3" (75)	24	0312AA
4" (100)	24	0412AA
5" (125)	24	0512AA
6" (150)	8	0612AA
8" (200)	6	0812AA
10" (250)	3	1012AA

### Split Coupler



Diameter in (mm)	Package Qty.	Product Code
3" (75)	36	0311AA
4" (100)	24	0411AA
5" (125)	24	0511AA
6" (150)	14	0611AA
8" (200)	8	0811AA
10" (250)	12	1011AA

# Singlewall Fittings

End Plugs, End Caps & Adapters

## Snap End Caps\*



0432AA



0332AA, 0832AA, 1032AA

Diameter in (mm)	Package Qty.	Product Code
3" (75)	30	0332AA
4" (100)	40	0432AA
8" (200)	6	0832AA
10" (250)	6	1032AA

## Split End Caps\*



0431AA, 0531AA, 0631AA

Diameter in (mm)	Package Qty.	Product Code
4" (100)	34	0431AA
5" (125)	24	0531AA
6" (150)	12	0631AA
12"		1267AA
15"		1567AA
18"		1867AA
24"		2467AA

## Internal End Plugs



Solid End Plug



Perforated End Plug

Diameter in (mm)	Package Qty.	Type	Product Code
3" (75)	100	Solid	0333AA
4" (100)	100	Solid	0433AA
		Perforated	0434AA
5" (125)	100	Solid	0533AA
6" (150)	50	Solid	0633AA

## Dissimilar Snap Adapters



0462AA



0362AA, 0562AA  
0662AA, 0862AA

Diameter in (mm)	Package Qty.	Type	Product Code
3" (75)	24	Clay	0362AA
4" (100)	24	Clay	0462AA
5" (125)	24	Clay	0562AA
6" (150)	11	Clay	0662AA
8" (200)	9	Clay	0862AA
4" (100)	24	Sewer & Drain	0467AA
4" (100)	24	Septic Tank	0463AA

## Downspout Adapters



0364AA



0464AA



0465AA



0466AA



0664AA

Pipe Diameter x Downspout Dimensions in (mm)	Package Qty.	Product Code
3" x 3.25" x 2.5" (75 x 81 x 62.5)	24	0364AA
4" x 3.25" x 2.5" (100 x 81 x 62.5)	24	0464AA
4" x 4.25" x 3" (100 x 106 x 75)	20	0465AA
4" x 2.56" x 2.56" (100 x 63 x 63)	24	0466AA
6" x 4" x 6" (150 x 100 x 150)	1	0664AA

\*End caps are for horizontal applications only. End caps are not permitted to be used in any vertical applications. Misuse or failure to properly secure end caps may result in damage to persons or property or may result in injury or death.

# Singlewall Fittings

## Tees

### Snap Tee



0421AA



0321AA, 0525AA, 0626AA

Diameter in (mm)	Package Qty.	Product Code
3" (75)	12	0321AA
4" (100)	8	0421AA
5" (125)	4	0525AA
6" (150)	3	0626AA

### Blind Tee



Diameter in (mm)	Package Qty.	Product Code
4" (100)	8	0441AA
6" (150)	3	0641AA

### Reducing Tee



Diameter Main x Stub in (mm)	Package Qty.	Product Code
5" x 4" (125 x 100)	4	0524AA
6" x 4" (150 x 100)	3	0624AA

### Multiple Tee



Diameter Main x Stub in (mm)	Package Qty.	Product Code
6" x 3"/4"/5"/6" (150 x 75/100/125/150)	3	0644AA
8" x 4"/5"/6"/8" (200 x 100/125/150/200)	1	0844AA
10" x 6"/8"/10" (250 x 150/200/250)	1	1044AA

### Blind Multiple Tee



Diameter Main x Stub in (mm)	Package Qty.	Product Code
8" x 4"/6"/8" (200 x 100/150/200)	1	0847AA
10" x 8"/10" (250 x 200/250)	1	1047AA
12" x 10"/12" (300 x 250/300)	1	1247AA

### Multiple Cross Tee



Diameter in (mm)	Package Qty.	Product Code
6" (150)	3	0654AA

# Singlewall Fittings

Tap Tee, Elbow, Wye

## Internal Tap Tee



Diameter Main x Stub in (mm)	Package Qty.	Product Code
3" x 6"/8" (75 x 150/200)	24	0350AA
4" x 6"/8"/10"/12" (100 x 150/200/250/300)	24	0480AA
5" x 10"/12" (125 x 250/300)	25	0550AA
6" x 15"/18"/24" (150 x 375/450/600)	25	0650AA
6" x 30"/36" (150 x 750/900)	25	0670AA

## Agriculture Internal Tap Tee



Diameter Main x Stub in (mm)	Package Qty.	Product Code
4" x 6"/8" (100 x 150/200)	24	0450AA
4" x 10"/12" (100 x 250/300)	24	0410AA
4" x 6"/8"/10"/12" (100 x 150/200/250/300)	24	0480AA

## Wye



Diameter in (mm)	Package Qty.	Product Code
3" (75)	7	0322AA
4" (100)	5	0422AA
5" (125)	4	0522AA
6" (150)	2	0622AA
8" (200)	1	0822AA

## 90° Snap Elbow



0490AA

0390AA

Diameter in (mm)	Package Qty.	Product Code
3" (75)	12	0390AA
4" (100)	10	0490AA

## 45° Snap Elbow



Diameter in (mm)	Package Qty.	Product Code
4" (100)	15	0445AA

# Specialty Fittings

## Hickenbottom & Precision Intakes

### Hickenbottom



Hickenbottom Riser

Hickenbottom Restrictor

Size in (mm)	Description	Product Code
5" x 1" (125 x 25)	Orange Intake (12 holes)	5013GC
5" x 1" (125 x 25)	Orange Riser with Cap Top	5023GC
5" x 5/16" (125 x 8)	Orange Extension	5033GC
5" (125)	Blind Tee	5043GC
5" (125)	Restrictor	5063GC
6" x 1" (150 x 25)	Orange Riser with Cap Top	6023GC
6" x 5/16" (150 x 8)	Orange Extension	6033GC
6" (150)	Black Slotted Intake	6073GC
6" (150)	Black Blank Section	6053GC
6" (150)	Black Riser Blind Tee	6043GC
6" (150)	Restrictor	6063GC
8" x 1" (200 x 25)	Orange Riser with Cap Top	0823GC
8" x 5/16" (200 x 8)	Orange Extension	0833GC
8" (200)	Black Slotted Intake	0873GC
8" (200)	Black Blank Section	0853GC
8" (200)	Black Riser Blind Tee	0843GC
8" (200)	Restrictor	0863GC
10" x 1" (250 x 25)	Orange Riser with Cap Top	1023GC
10" x 5/16" (250 x 8)	Orange Extension	1033GC
10" (250)	Black Slotted Intake	1073GC
10" (250)	Black Blank Section	1053GC
10" (250)	Black Riser Blind Tee	1043GC
12" x 1" (300 x 25)	Orange Riser with Cap Top	1223GC
12" x 5/16" (300 x 8)	Orange Extension	1233GC
12" (300)	Black Slotted Intake	1273GC
12" (300)	Black Blind Tee	1243GC

### Precision Intakes



Size in (mm)	Description	Product Code
6" x 1" (150 x 25)	Yellow Riser with Cap Top	6023GCV
6" x 5/16" (150 x 8)	Yellow Extension	6033GCV
6" (150)	Black Riser Blind Tee	6043GCV
6" (150)	Restrictor	6063GCV
8" x 1" (200 x 25)	Yellow Riser with Cap Top	0823GCV
8" x 5/16" (200 x 8)	Yellow Extension	0833GCV
8" (200)	Black Riser Blind Tee	0843GCV
8" (200)	Restrictor	0863GCV
10" x 1" (250 x 25)	Yellow Riser with Cap Top	1023GCV
10" x 5/16" (250 x 8)	Yellow Extension	1033GCV
10" (250)	Black Riser Blind Tee	1043GCV

### Quick Drain Riser



Size Diameter x inlet in (mm)	Product Code
6" x 6" (150 x 150)	0606QD
10" x 6" (250 x 150)	1006QD
10" x 8" (250 x 200)	1008QD
6" x 6" (150 x 150) adjustable inlet	0606TPTQD

# Specialty Fittings

End Sections, Trash & Animal Guards

## Animal Metal Finger Guards



Size in (mm)	Material	Quantity	Product Code
4" (100)	Zinc	100	0470DA
4" (100)	Stainless Steel	100	0470DASS
6" (150)	Zinc	100	0670DA
6" (150)	Stainless Steel	100	0670DASS
8" (200)	Zinc	50	0870DA
8" (200)	Stainless Steel	1	0870DASS
10" (250)	Zinc	30	1070DA
12" (300)	Zinc	30	1270DA
15" (375)	Zinc	10	1570DA
18" (450)	Zinc	1	1870DA
24" (600)	Zinc	1	2470DA
30" (750)		1	3070DA
36" (900)		1	3670DA
42" (1050)		1	4270DA
48" (1200)		1	4870DA

## Flared End Sections



Size in (mm)	Product Code
10" (250)	1015NP
12"/15" (300/375)	1215NP
18" (450)	1810NP
24" (600)	2410NP

## Animal Solid Guards



Size in (mm)	Product Code
4" (100)	0471DA
6" (150)	0671DA
8" (200)	0871DA
10" (250)	1071DA
12" (300)	1271DA

## Bar Guards



Size in (mm)	Product Code
4" (100)	0420DA
5" (125)	0520DA
6" (150)	0620DA
8" (200)	0820DA
10" (250)	1020DA
12" (300)	1220DA
15" (375)	1520DA
18" (450)	1820DA
24" (600)	2420DA
30" (750)	3020DA
36" (900)	3620DA

## Flap Gates



Size in (mm)	Product Code
4" (100)	0440DA
6" (150)	0640DA
8" (200)	0840DA
10" (250)	1040DA
12" (300)	1240DA
15" (375)	1540DA
18" (450)	1840DA
24" (600)	2440DA
30" (750)	3040DA
36" (900)	3640DA



# Nyloplast

## Drain Basins

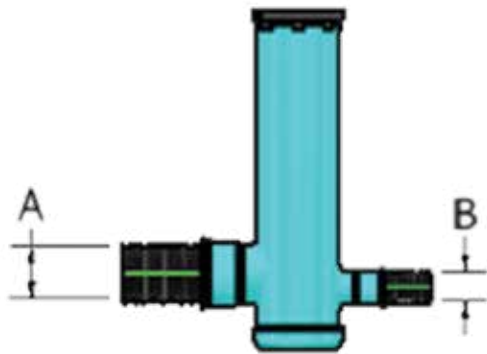

Change Diameter

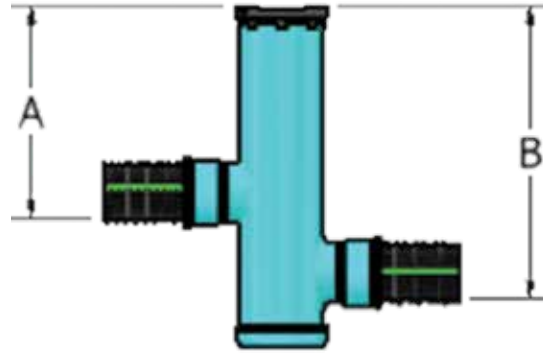

Change Elevation

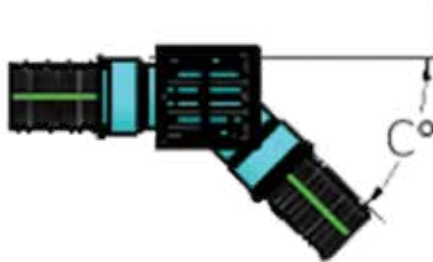

Change Direction

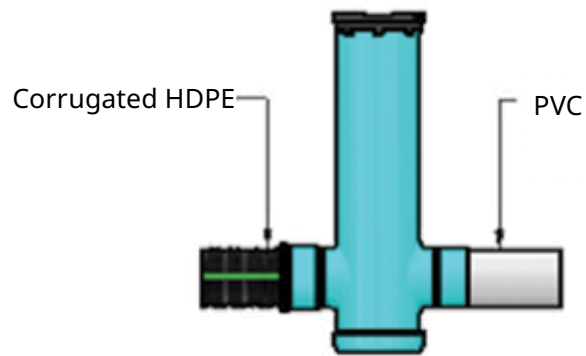

Change Pipe

Part Number	Product Description	Available Outlets
2808AG__	8" (200 mm) Custom Basin	4"-8" (100-200 mm)
2810AG__	10" (250 mm) Custom Basin	4"-10" (100-250 mm)
2812AG__	12" (300 mm) Custom Basin	4"-12" (100-300 mm)
2815AG__	15" (375 mm) Custom Basin	4"-15" (100-375 mm)
2818AG_	18" (450 mm) Custom Basin	4"-18" (100-450 mm)
2824AG__	24" (600 mm) Custom Basin	4"-24" (100-600 mm)
2830AG__	30" (750 mm) Custom Basin	4"-30" (100-750 mm)
2836AG__	36" (900 mm) Custom Basin	4"-36" (100-900 mm)

28 08 AG \_\_

- "28" is our standard drain basin series. Includes all round grate options
- The next two numbers represent the basin body diameter
- AG is the product code for Drain Basins
- The second set of numbers is the overall height of the drain basin in foot increments 3, 5, 7, 10

Drain Basins connect to these common pipe types: ADS N12, ADS HP, PVC SCH.40, SCH.80, PVC. If pipe type does not fit any of these please note type of pipe and outside diameter of pipe and call Nyloplast at 866-888-8479 for technical assistance.



# Nyloplast

## Inline Drains

### Inline Drains

Part Number	Product Description	Available Outlets
2708AG__X	8" (200 mm) Inline Drain	4"-8" (100-200 mm)
2710AG__X	10" (250 mm) Inline Drain	4"-10" (100-250 mm)
2712AG__X	12" (300 mm) Inline Drain	4"-12" (100-300 mm)
2715AG__X	15" (375 mm) Inline Drain	4"-15" (100-375 mm)
2718AG__X	18" (450 mm) Inline Drain	4"-18" (100-450 mm)
2724AG__X	24" (600 mm) Inline Drain	4"-24" (100-600 mm)
2730AG__X	30" (750 mm) Inline Drain	4"-30" (100-750 mm)
2736AG__X	36" (900 mm) Inline Drain	4"-36" (100-900 mm)

The set of blanks is the pipe size adapting to (choose from 04, 06, 08, 10, 12, 15, 18, 24 or 30)

The **X** represents the pipe type adapting to. Replace **X** with one of the following:

**N** = ADS dual wall pipe

**D** = DWV PVC (Sch 40 or Sch 80)

**S** = SWR PVC (ASTM D3034; SDR 35 SWR & SDR 26 SWR PVC)

**O** = Big O/Armtec

If pipe type does not fit any of these, leave **X** blank and note type of pipe and outside diameter of pipe.



### Universal Inline Drains

Part Number	Product Description	Available Outlets
2708AGNB	HDPE gasketed connections	4"-8" (100-200 mm)
2708AGSB	PVC glue joint connections	4"-8" (100-200 mm)
2712AGNB	HDPE gasketed connections	6"-12" (150-300 mm)
2712AGSB	PVC glue joint connections	6"-10" (150-250 mm)
2712AG4NB	HDPE gasketed connections	4"-12" (100-300 mm)
2712AG4SB	PVC glue joint connections	4"-10" (100-250 mm)



\* 12" HDPE outlet connections are not gasketed. Watertight connection with gasket is available upon request

# Nyloplast

## Inspection Ports

### Inspection Ports for StormTech Systems

Part Number	Product Description
2708AG4IPKIT	8" X 4" (200 x 100 mm) Inspection Port Kit
2712AG6IPKIT	12" X 6" (300 x 150 mm) Inspection Port Kit
2712AG10IPKIT	12" X 10" (300 x 250 mm) Inspection Port Kit

\*\_IPKIT includes frame & solid cover, PVC inspection port body, SDR-35 Inserta Tee, and 4 oz. water solution bottle



### Inspection Ports for StormTech Systems

(Solid cover included; Inserta Tee not included)

Part Number	Product Description
2708AG4IP	8" X 4" (200 x 100 mm) Inspection Port ONLY
2712AG6IP	12" X 6" (300 x 150 mm) Inspection Port ONLY
2712AG10IP	12" X 10" (300 x 250 mm) Inspection Port ONLY



# Nyloplast

## Curb Inlet Structures

### Drain Basins

Part Number	Product Description	Available Outlets
3012AGS__	2' x 2' (.6 x .6 m) Square Grate	4"-12" (100-300 mm)
3015AGS__	2' x 2' (.6 x .6 m) Square Grate	4"-15" (100-375 mm)
3018AGS__	2' x 2' (.6 x .6 m) Square Grate	4"-18" (100-450 mm)
3024AGS__	2' x 2' (.6 x .6 m) Square Grate	4"-24" (100-600 mm)
3030AGS__	2' x 2' (.6 x .6 m) Square Grate	4"-30" (100-750 mm)
3036AGS__	2' x 2' (.6 x .6 m) Square Grate	4"-36" (100-900 mm)
3018AGR__	2' x 3' (.6 x .9 m) Rect. Grate	4"-18" (100-450 mm)
3024AGR__	2' x 3' (.6 x .9 m) Rect. Grate	4"-24" (100-600 mm)
3030AGR__	2' x 3' (.6 x .9 m) Rect. Grate	4"-30" (100-750 mm)
3036AGR__	2' x 3' (.6 x .9 m) Rect. Grate	4"-36" (100-900 mm)

The second set of numbers is the overall height of the drain basin in foot increments 3, 5, 7, 10

Drain Basin connects to these common pipe types:

- N** = ADS dual wall pipe
- D** = DWV PVC (Sch 40 or Sch 80)
- S** = SWR PVC (ASTM D3034; SDR 35 SWR & SDR 26 SWR PVC)
- O** = Big O/Armtec

If pipe type does not fit any of these please note type of pipe and outside diameter of pipe and call Nyloplast at 866-888-8479 for technical assistance.

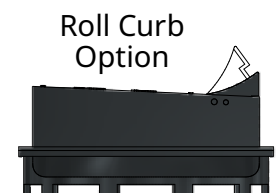
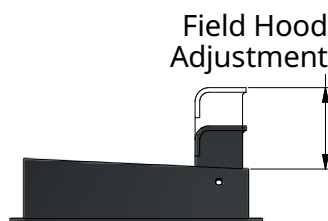
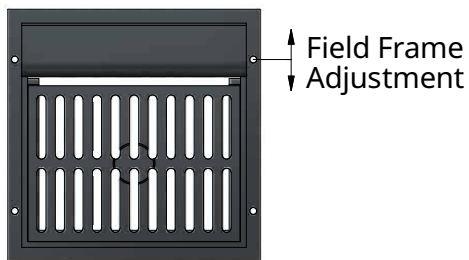

# Nyloplast

## Road & Highway Structures

### Drain Basins

Part Number	Product Description	Available Outlets
3212AGS__	2' x 2' (.6 x .6 m) Square Grate	4"-12" (100-300 mm)
3215AGS__	2' x 2' (.6 x .6 m) Square Grate	4"-15" (100-375 mm)
3218AGS__	2' x 2' (.6 x .6 m) Square Grate	4"-18" (100-450 mm)
3224AGS__	2' x 2' (.6 x .6 m) Square Grate	4"-24" (100-600 mm)
3230AGS__	2' x 2' (.6 x .6 m) Square Grate	4"-30" (100-750 mm)
3236AGS__	2' x 2' (.6 x .6 m) Square Grate	4"-36" (100-900 mm)
3218AGR__	2' x 3' (.6 x .9 m) Rect. Grate	4"-18" (100-450 mm)
3224AGR__	2' x 3' (.6 x .9 m) Rect. Grate	4"-24" (100-600 mm)
3230AGR__	2' x 3' (.6 x .9 m) Rect. Grate	4"-30" (100-750 mm)
3236AGR__	2' x 3' (.6 x .9 m) Rect. Grate	4"-36" (100-900 mm)

The second set of numbers is the overall height of the drain basin in foot increments 3, 5, 7, 10

Drain Basin connects to these common pipe types:

- N** = ADS dual wall pipe
- D** = DWV PVC (Sch 40 or Sch 80)
- S** = SWR PVC (ASTM D3034; SDR 35 SWR & SDR 26 SWR PVC)
- O** = Big O/Armtec

If pipe type does not fit any of these please note type of pipe and outside diameter of pipe and call Nyloplast at 866-888-8479 for technical assistance.



# Nyloplast

## Grates

### Drop-In Grates

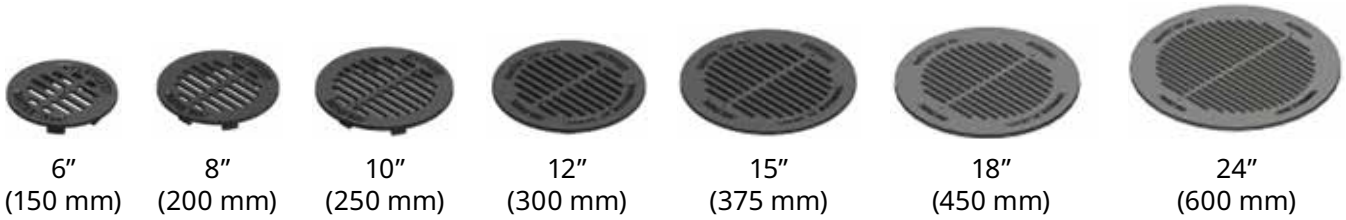

### Domed Grates



### Standard Grates



### Pedestrian Grates

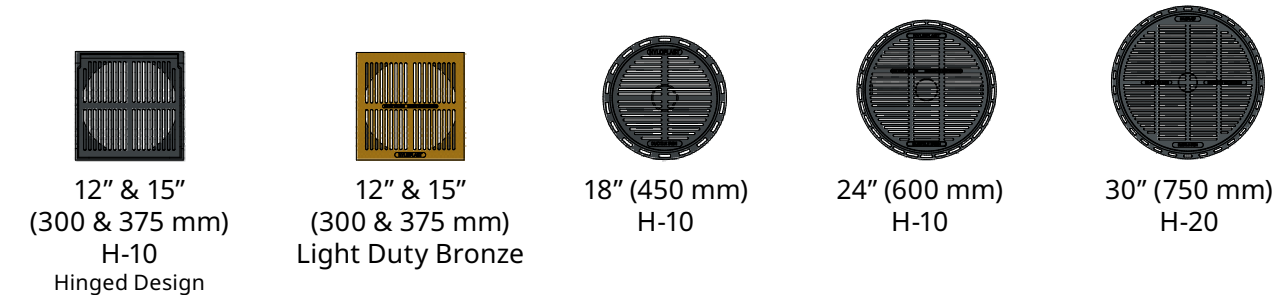

### Solid Cover Grates

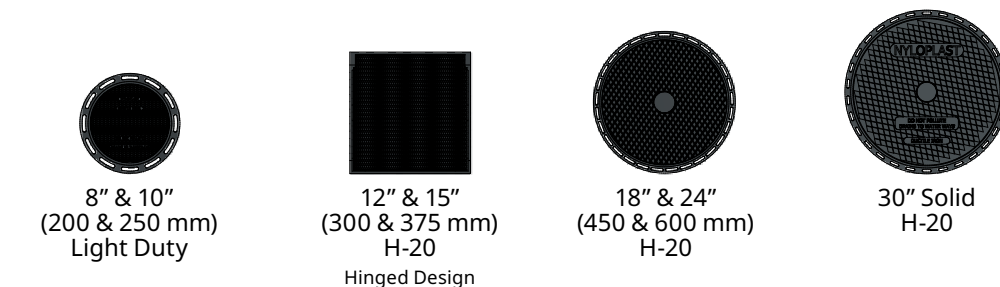

# Nyloplast

## Riser Sections, Sump Inserts & Add-A-Branch

### Riser Sections

Part Number	Product Description
2908AG__	8" (200 mm) Riser Section
2910AG__	10" (250 mm) Riser Section
2912AG__	12" (300 mm) Riser Section
2915AG__	15" (375 mm) Riser Section
2918AG__	18" (450 mm) Riser Section
2924AG__	24" (600 mm) Riser Section
2930AG__	30" (750 mm) Riser Section
2936AG__	36" (900 mm) Riser Section

Blanks are the riser's height, choose from 01-07 (one foot- two foot).

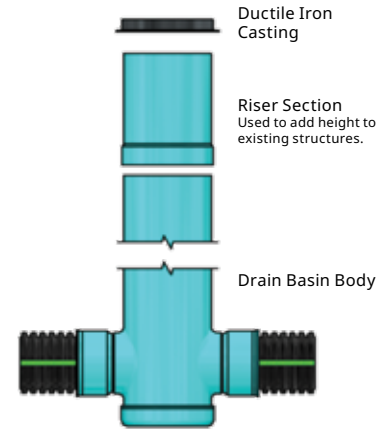

### Sump Inserts

Part Number	Basin Diameter
3812AGSI	12" (300 mm)
3815AGSI	15" (375 mm)
3818AGSI	18" (450 mm)
3824AGSI	24" (600 mm)
3830AGSI	30" (750 mm)



### Add-A-Branch Kits

Part No.	Pipe Size	Min. Basin Size
6004AG_	4" (100 mm)	8" (200 mm)
6006AG_	6" (150 mm)	10" (250 mm)
6008AG_	8" (200 mm)	12" (300 mm)
6010AG__	10" (250 mm)	15" (375 mm)
6012AG_	12" (300 mm)	18" (450 mm)
6015AG_	15" (375 mm)	24" (600 mm)
6004AG_30	4" (100 mm)	Spec. to 30" (750 mm) & 36" (900 mm)
6006AG_30	6" (150 mm)	Spec. to 30" (750 mm) & 36" (900 mm)
6008AG_30	8" (200 mm)	Spec. to 30" (750 mm) & 36" (900 mm)
6010AG_30	10" (250 mm)	Spec. to 30" (750 mm) & 36" (900 mm)
6012AG_30	12" (300 mm)	Spec. to 30" (750 mm) & 36" (900 mm)
6015AG_30	15" (375 mm)	Spec. to 30" (750 mm) & 36" (900 mm)
6018AG_30	18" (450 mm)	Spec. to 30" (750 mm) & 36" (900 mm)
6024AG_36	24" (600 mm)	Spec. to 36" (900 mm)



# Nyloplast

## Weir Structures

### Weir Structures

Part Number	Product Description
2824AG_WE	24" (600 mm) Custom Basin with Grate & Weir
2830AG_WE	30" (750 mm) Custom Basin with Grate & Weir
2836AG_WE	36" (900 mm) Custom Basin with Grate & Weir
3024AGS_WE	24" (600 mm) Curb Inlet Structure with 2' x 2' (0.6 x 0.6 m) Grate & Weir
3030AGS_WE	30" (750 mm) Curb Inlet Structure with 2' x 2' (0.6 x 0.6 m) Grate & Weir
3036AGS_WE	36" (900 mm) Curb Inlet Structure with 2' x 2' (0.6 x 0.6 m) Grate & Weir
3024AGR_WE	24" (600 mm) Curb Inlet Structure with 2' x 3' (0.6 x 0.9 m) Grate & Weir
3030AGR_WE	30" (750 mm) Curb Inlet Structure with 2' x 3' (0.6 x 0.9 m) Grate & Weir
3036AGR_WE	36" (900 mm) Curb Inlet Structure with 2' x 3' (0.6 x 0.9 m) Grate & Weir
3224AGS_WE	24" (600 mm) Road & Hwy Structure with 2' x 2' (0.6 x 0.6 m) Grate & Weir
3230AGS_WE	30" (750 mm) Road & Hwy Structure with 2' x 2' (0.6 x 0.6 m) Grate & Weir
3236AGS_WE	36" (900 mm) Road & Hwy Structure with 2' x 2' (0.6 x 0.6 m) Grate & Weir
3224AGR_WE	24" (600 mm) Road & Hwy Structure with 2' x 3' (0.6 x 0.9 m) Grate & Weir
3230AGR_WE	30" (750 mm) Road & Hwy Structure with 2' x 3' (0.6 x 0.9 m) Grate & Weir
3236AGR_WE	36" (900 mm) Road & Hwy Structure with 2' x 3' (0.6 x 0.9 m) Grate & Weir

The blank is the height of structure, either 5' or 10' (1.5 or 3 m).

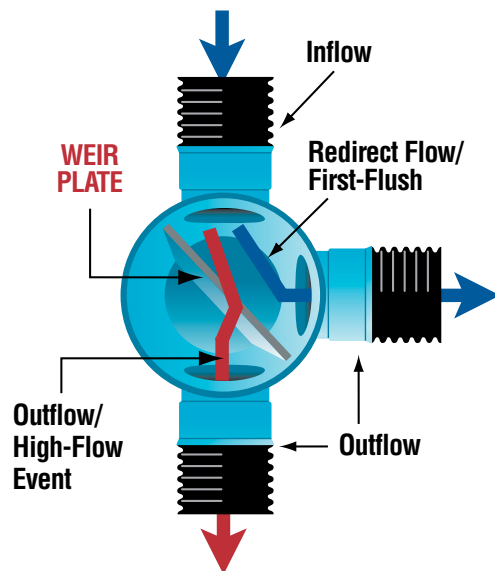



# Retention/Detention

LandMax Manifolds - Size on Size Stubs

## Plain End Component Manifold

Pipe Size in (mm)	Product Code		
	Single	Double	Triple
12" (300)	1251AN	1252AN	1253AN
15" (375)	1551AN	1552AN	1553AN
18" (450)	1851AN	1852AN	1853AN
24" (600)	2451AN	2452AN	2453AN
30" (750)	3051AN	3052AN	3053AN
36" (900)	3651AN	3652AN	3653AN
42" (1050)	4251AN	4252AN	
48" (1200)	4851AN	4852AN	
60" (1500)	6051AN	6052AN	



N-12 PLAIN END SINGLE



N-12 PLAIN END DOUBLE



N-12 PLAIN END TRIPLE

## Watertight Bell End Component Manifold

Pipe Size in (mm)	Product Code		
	Single	Double	Triple
12" (300)	1251AN65B	1252AN65B	1253AN65B
15" (375)	1551AN65B	1552AN65B	1553AN65B
18" (450)	1851AN65B	1852AN65B	1853AN65B
24" (600)	2451AN65B	2452AN65B	2453AN65B
30" (750)	3051AN65B	3052AN65B	3053AN65B
36" (900)	3651AN65B	3652AN65B	3653AN65B
42" (1050)	4251AN65B	4252AN65B	
48" (1200)	4851AN65B	4852AN65B	
60" (1500)	6051AN65B	6052AN65B	



N-12 WT BELL END SINGLE



N-12 WT BELL END DOUBLE



N-12 WT BELL END TRIPLE

## Watertight Gasket End Component Manifold

Pipe Size in (mm)	N-12 WT Component Manifold Gasket End Product Code		
	Single	Double	Triple
12" (300)	1251AN65G	1252AN65G	1253AN65G
15" (375)	1551AN65G	1552AN65G	1553AN65G
18" (450)	1851AN65G	1852AN65G	1853AN65G
24" (600)	2451AN65G	2452AN65G	2453AN65G
30" (750)	3051AN65G	3052AN65G	3053AN65G
36" (900)	3651AN65G	3652AN65G	3653AN65G
42" (1050)	4251AN65G	4252AN65G	
48" (1200)	4851AN65G	4852AN65G	
60" (1500)	6051AN65G	6052AN65G	



N-12 WT GASKET END SINGLE



N-12 WT GASKET END DOUBLE



N-12 WT GASKET END TRIPLE

NOTE: CONTACT YOUR LOCAL SALES REPRESENTATIVE FOR AVAILABILITY OF SIZES NOT LISTED ABOVE. \*FOR RETENTION SYSTEMS ONLY.

# Retention/Detention

## LandMax Manifold Bend

### N-12 90° Bend Manifold

Pipe Size in (mm)	Plain End	WT Bell/Bell	WT Gasket/ Gasket	WT Bell/Gasket
12" (300)	1298AN	1298AN65BB	1298AN65GG	1298AN65BG
15" (375)	1598AN	1598AN65BB	1598AN65GG	1598AN65BG
18" (450)	1898AN	1898AN65BB	1898AN65GG	1898AN65BG
24" (600)	2498AN	2498AN65BB	2498AN65GG	2498AN65BG
30" (750)	3098AN	3098AN65BB	3098AN65GG	3098AN65BG
36" (900)	3698AN	3698AN65BB	3698AN65GG	3698AN65BG
42" (1050)	4298AN	4298AN65BB	4298AN65GG	4298AN65BG
48" (1200)	4898AN	4898AN65BB	4898AN65GG	4898AN65BG
60" (1500)	6098AN	6098AN65BB	6098AN65GG	6098AN65BG



**N-12  
PLAIN END**



**N-12 WT  
BELL x BELL**



**N-12 WT  
GASKET x GASKET**



**N-12 WT  
BELL x GASKET**

NOTE: CONTACT YOUR LOCAL SALES REPRESENTATIVE FOR AVAILABILITY OF SIZES NOT LISTED ABOVE.  
\*FOR RETENTION SYSTEMS ONLY.

# Retention/Detention

## LandMax® Accessories

### Fabricated Manifold Inlet Riser

Pipe Size in (mm)	Plain End
4" (100)	0403AN
6" (150)	0603AN
8" (200)	0803AN
10" (250)	1003AN
12" (300)	1203AN
15" (375)	1503AN
18" (450)	1803AN
24" (600)	2403AN

This component item can only be ordered with standard manifold fittings or standard pipe. When ordering this component item, be sure to include shop drawing showing the location of inlet riser on standard manifold or pipe product.

Contact your local sales representative for acceptable size combinations, i.e.: 48" manifold fitting with a 24" diameter riser. **Not all combinations of inlet riser on standard manifold or pipe product are allowed.**

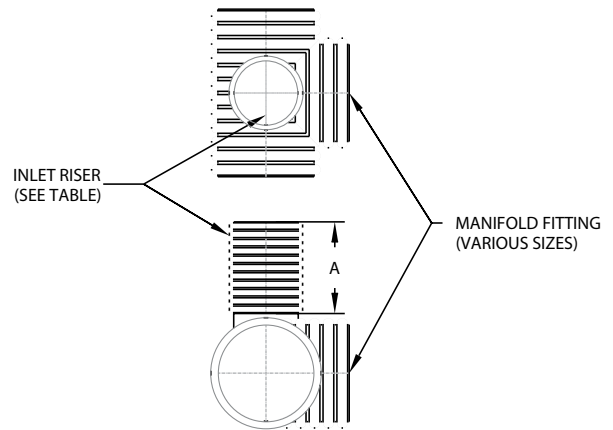

### Fabricated Manifold Cleanout Riser

Pipe Size in (mm)	Plain End
4" (100)	0402AN
6" (150)	0602AN
8" (200)	0802AN

This component item can only be ordered with standard manifold fittings. When ordering this component item, be sure to include shop drawing showing the location of inlet riser on standard manifold.

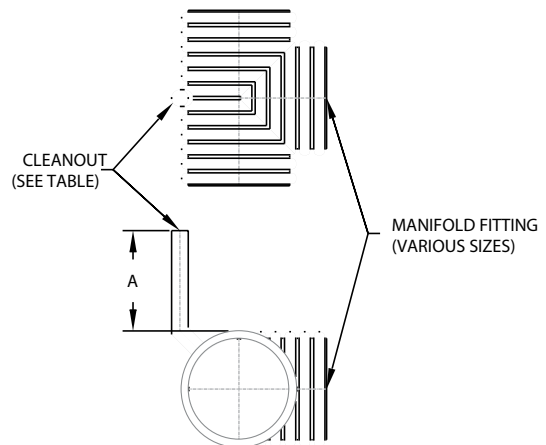

# Retention/Detention

## LandMax® Accessories

### Welded End Plates - ST & WT Connection

Pipe Size in (mm)	Plain End
4" (100)	0409AN
6" (150)	0609AN
8" (200)	0809AN
10" (250)	1009AN
12" (300)	1209AN
15" (375)	1509AN
18" (450)	1809AN
24" (600)	2409AN
30" (750)	3009AN
36" (900)	3609AN
42" (1050)	4209AN
48" (1200)	4809AN
60" (1500)	6009AN

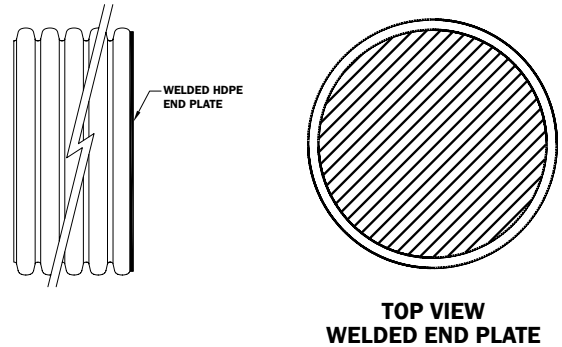

### Fabricated Stub

Pipe Size in (mm)	Plain End
4" (100)	0406AN
6" (150)	0606AN
8" (200)	0806AN
10" (250)	1006AN
12" (300)	1206AN
15" (375)	1506AN
18" (450)	1806AN
24" (600)	2406AN

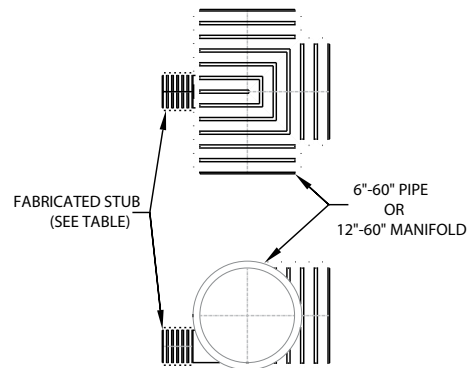

This component item can only be ordered with standard manifold fittings or standard pipe. When ordering this component item, be sure to include shop drawing showing the location of stub on standard manifold or pipe product.

Contact your local sales representative for acceptable size combinations, i.e.: 48" manifold fitting with a 24" stub. **Not all combinations of stub on standard manifold or pipe product are allowed.**

# Retention/Detention

## StormTech Chambers & End Caps

### StormTech Chambers



MC-7200      MC-4500      MC-3500      SC-800      DC-780      SC-740      SC-310      SC-160LP

Product Code	Dimensions L x W x H in (mm)	Nominal Weight lbs (kg)	Storage Capacity ft <sup>3</sup> (m <sup>3</sup> )	Minimum Installed Storage ft <sup>3</sup> (m <sup>3</sup> )
SC160	85.4" x 25" x 12" (2170 x 635 x 305)	24 (10.9)	6.85 (0.19)	15.0 (0.42)
SC310	85.4" x 34" x 16" (2170 x 864 x 406)	37 (16.8)	14.7 (0.42)	31.0 (0.88)
SC740	85.4" x 51" x 30" (2170 x 1295 x 762)	74 (33.6)	45.9 (1.30)	74.9 (2.12)
SC800	85.4" x 51" x 33" (2170 x 1295 x 838)	82 (37.1)	50.6 (1.43)	81.0 (2.29)
DC780	85.4" x 51" x 30" (2170 x 1295 x 762)	80 (36.3)	46.2 (1.30)	78.4 (2.20)
MC3500	90" x 77" x 45" (2286 x 1956 x 1143)	134 (60.8)	109.9 (3.11)	175.0 (4.96)
MC4500	52" x 100" x 60" (1321 x 2540 x 1524)	125 (56.7)	106.5 (3.01)	162.6 (4.60)
MC7200	83" x 100" x 60" (2108 x 2540 x 1524)	202 (91.6)	175.9 (4.98)	267.3 (7.57)

### StormTech End Caps



MC-7200 End Cap      MC-4500 End Cap      MC-3500 End Cap      SC-800 End Cap      DC-780 End Cap      SC-740 End Cap      SC-310 End Cap      SC-160LP End Cap

Product Code	Dimensions L x W x H in (mm)	Nominal Weight lbs (kg)	Storage Capacity ft <sup>3</sup> (m <sup>3</sup> )	Minimum Installed Storage ft <sup>3</sup> (m <sup>3</sup> )
SC160IEPP	4.4" x 18.6" x 11.7" (112 x 472 x 297)	2 (0.6)		
SC310EPE	9.9" x 29" x 15.6" (252 x 737 x 396)	4 (1.8)		
SC740EPE	12.2" x 45.9" x 29.3" (310 x 1166 x 744)	13 (5.9)		
SC740EPE	12.2" x 45.9" x 29.3" (310 x 1166 x 744)	13 (5.9)		
SC800EPE	12.2" x 46.5" x 32.6" (310 x 1181 x 828)	16 (7.3)		
MC3500IEPP	26.5" x 71" x 45.1" (673 x 1803 x 1145)	49 (22.2)	14.9 (0.42)	45.1 (1.28)
MC4500IEPP	35.1" x 90.2" x 59.4" (892 x 2291 x 1509)	90 (40.8)	39.5 (1.12)	115.3 (3.26)
MC7200IEPP	35.1" x 90.2" x 59.4" (892 x 2291 x 1509)	90 (40.8)	39.5 (1.12)	115.3 (3.26)

# Retention/Detention

## Fabricated End Cap

### Top Inlet



Type	Diameter in (mm)	Product Code
SC-310	6" (150)	SC310EPE06T
	6" (150)	SC310EPE06TPC
	8" (200)	SC310EPE08T
	8" (200)	SC310EPE08TPC
	10" (250)	SC310EPE10T
	10" (250)	SC310EPE10TPC
SC-740/DC-780	6" (150)	SC740EPE06T
	8" (200)	SC740EPE08T
	10" (250)	SC740EPE10T
	12" (300)	SC740EPE12T
	15" (375)	SC740EPE15T
	18" (450)	SC740EPE18T
	18" (450)	SC740EPE18LT
	18" (450)	SC740EPE18TPC
SC-800	6" (150)	SC800EPE06TPC
	8" (200)	SC800EPE08TPC
	10" (250)	SC800EPE10TPC
	12" (300)	SC800EPE12TPC
	15" (375)	SC800EPE15TPC
	18" (450)	SC800EPE18TPC

Type	Diameter in (mm)	Product Code
MC-3500	6" (150)	MC3500IEPP06T
	8" (200)	MC3500IEPP08T
	10" (250)	MC3500IEPP10T
	12" (300)	MC3500IEPP12T
	15" (375)	MC3500IEPP15T
	18" (450)	MC3500IEPP18T
	18" (450)	MC3500IEPP18TC
	18" (450)	MC3500IEPP18TW
	24" (600)	MC3500IEPP24T
	24" (600)	MC3500IEPP24TW
	24" (600)	MC3500IEPP24TC
MC-4500 & MC-7200	8" (200)	MC4500REPE08T
	12" (300)	MC4500REPE12T
	15" (375)	MC4500REPE15T
	18" (450)	MC4500REPE18TW
	18" (450)	MC4500REPE18TC
	24" (600)	MC4500REPE24TW
24" (600)	MC4500REPE24TC	

# Retention/Detention

## Fabricated End Cap

### Bottom Inlet



Type	Diameter in (mm)	Product Code
SC-310	6" (150)	SC310EPE06B
	6" (150)	SC310EPE06BPC
	8" (200)	SC310EPE08B
	8" (200)	SC310EPE08BPC
	10" (250)	SC310EPE10B
	10" (250)	SC310EPE10BPC
	12" (300)	SC310EPE12B
SC-740/DC-780	6" (150)	SC740EPE06B
	8" (200)	SC740EPE08B
	10" (250)	SC740EPE10B
	12" (300)	SC740EPE12B
	15" (375)	SC740EPE15B
	18" (450)	SC740EPE18B
	18" (450)	SC740EPE18LB
	24" (600)	SC740EPE24B
	24" (600)	SC740EPE24BL
24" (600)	SC740EPE24LB	
SC-800	6" (150)	SC800EPE06BPC
	8" (200)	SC800EPE08BPC
	10" (250)	SC800EPE10BPC
	12" (300)	SC800EPE12BPC
	15" (375)	SC800EPE15BPC
	18" (450)	SC800EPE18BPC
	24" (600)	SC800EPE24BPC

Type	Diameter in (mm)	Product Code
MC-3500	6" (150)	MC3500IEPP06B
	8" (200)	MC3500IEPP08B
	10" (250)	MC3500IEPP10B
	12" (300)	MC3500IEPP12B
	15" (375)	MC3500IEPP15B
	18" (450)	MC3500IEPP18BC
	18" (450)	MC3500IEPP18BW
	24" (600)	MC3500IEPP24BC
	24" (600)	MC3500IEPP24BW
	30" (750)	MC3500IEPP30BC
MC-4500 & MC-7200	8" (200)	MC4500REPE08B
	12" (300)	MC4500REPE12B
	15" (375)	MC4500REPE15B
	18" (375)	MC4500REPE18B
	18" (450)	MC4500REPE18BW
	18" (450)	MC4500REPE18BC
	24" (600)	MC4500REPE24BW
	24" (600)	MC4500REPE24BC
	30" (450)	MC4500REPE30BC
	36" (600)	MC4500REPE36BC
42" (750)	MC4500REPE42BC	



# Retention/Detention

*StormTech 90° Bends, Size-On-Size Single Manifolds*



## SC-310 90° Bends

Diameter in (mm)	Product Code
8" (200)	0898AN31
12" (300)	1298AN31



## SC-310

Diameter in (mm)	Product Code
8" (200)	0851AN3108
12" (300)	1251AN3112

## SC-740/SC-800/DC-780 90° Bends

Diameter in (mm)	Product Code
12" (300)	1298AN74
15" (375)	1598AN74
18" (450)	1898AN74
24" (600)	2498AN74
24" (600)	2498ANL74

## SC-740/SC-800/DC-780

Diameter in (mm)	Product Code
12" (300)	1251AN7412
15" (375)	1551AN7415
18" (450)	1851AN7418
24" (600)	2451AN7424
24" (600)	2451ANL7424

## MC-3500 90° Bends

Diameter in (mm)	Product Code
12" (300)	1298AN3512
15" (375)	1598AN3515
18" (450)	1898AN3518
24" (600)	2498AN3524
24" (600)	2498ANL3524

## MC-3500

Diameter in (mm)	Product Code
12" (300)	1251AN3512
15" (375)	1551AN3515
18" (450)	1851AN3518
24" (600)	2451AN3524
24" (600)	2451ANL3524

## MC-4500/MC-7200 90° Bends

Diameter in (mm)	Product Code
12" (300)	1298AN4512
15" (375)	1598AN4515
18" (450)	1898AN4518
24" (600)	2498AN4524
24" (600)	2498ANL4524

## MC-4500/MC-7200

Diameter in (mm)	Product Code
12" (300)	1251AN4512
15" (375)	1551AN4515
18" (450)	1851AN4518
24" (600)	2451AN4524
24" (600)	2451ANL4524

# Retention/Detention

## StormTech Reducing Single Manifold & FLAMP



### SC-310

Size in (mm)	Product Code
12" x 8" (300 x 200)	1251AN3108
18" x 8" (450 x 200)	1851AN3108
18" x 12" (450 x 300)	1851AN3112
24" x 8" (600 x 200)	2451AN3108
24" x 8" (600 x 200)	2451ANL3108
24" x 12" (600 x 300)	2451AN3112
24" x 12" (600 x 300)	2451ANL3112



### MC-3500

Size in (mm)	Product Code
30" x 24" (750 x 600)	3051AN3524
30" x 24" (750 x 600)	3051ANL3524
36" x 24" (900 x 600)	3651AN3524
42" x 24" (1050 x 600)	4251AN3524
48" x 24" (1200 x 600)	4851AN3524
48" x 24" (1200 x 600)	4851ANL3524

### SC-740/SC-800/DC-780

Size in (mm)	Product Code
24" x 15" (600 x 375)	2451AN7415
24" x 15" (600 x 375)	2451ANL7415
24" x 24" (600 x 600)	2451AN7424
24" x 24" (600 x 600)	2451ANL7424
30" x 15" (750 x 375)	3051AN7415
30" x 24" (750 x 600)	3051AN7424
30" x 24" (750 x 600)	3051ANL7424
36" x 15" (900 x 375)	3651AN7415
36" x 24" (900 x 600)	3651AN7424
42" x 15" (1050 X 375)	4251AN7415
42" x 24" (1050 X 600)	4251AN7424
42" x 24" (1050 X 600)	4251ANL7424
48" x 15" (1200 x 375)	4851AN7415
48" x 24" (1200 x 600)	4851AN7424

### MC-4500/MC-7200

Size in (mm)	Product Code
30" x 24" (750 x 600)	3051AN4524
30" x 24" (750 x 600)	3051ANL4524
36" x 24" (900 x 600)	3651AN4524
36" x 24" (900 x 600)	3651ANL4524
42" x 24" (1050 x 600)	4251AN4524
42" x 24" (1050 x 600)	4251ANL4524
48" x 24" (1200 x 600)	4851AN4524
48" x 24" (1200 x 600)	4851ANL4524



### FLAMPS

For Use With Chamber	Product Code
MC Series Chamber	MCFLAMP
SC-740, SC-800 and DC-780	SC74024RAMP
SC-310	SC31012RAMP

# Retention/Detention

## Aquabox, Rainwater Harvesting

### Aquabox

Description	Dimensions in. (mm)	Product Code
Aquabox HP	29.5" x 29.5" x 31.5" (750 x 750 x 800)	EDAQUFV1540
Aquabox HP Cube	29.5" x 29.5" x 9" (750 x 750 x 225)	EDAQUBCV200
Sidewall Grid HP	29.5" x 29.5" x 1.3" (750 x 750 x 32.5)	EDAQSWG033
Sidewall Grid Cube HP	29.5" x 12" x 1" (750 x 300 x 25)	EDAQSWG026
Top Cap	11.2" x 11.2" x 1" (280 x 280 x 25)	EDAQTOCV024
Double Joint Fastener	4.7" x 2.8" x 2.8" (117.5 x 70 x 70)	EDAQDOJ0070
Single Joint Fastener	4.7" x 2.8" x 1.4" (117.5 x 70 x 35)	EDAQJOI0035
D4 Cap HP	16" (400)	EDAQCCDV400



**Aquabox HP**



**Sidewall Grid**



**Top Cap**

### Water Harvesting Cisterns\*

Description	Diameter in. (mm)	Length ft. (m)	Capacity gal (L)
N-12	36" (900)	20' (6)	737 (2,790)
	42" (1050)	20' (6)	1,083 (4,100)
	48" (1200)	20' (6)	1,489 (5,636)
	60" (1500)	20' (6)	2,479 (9,384)
HP Storm	36" (900)	40' (12)	1,477 (5,591)
		60' (18)	2,215 (8,385)
	42" (1050)	40' (12)	2,169 (8,199)
		60' (18)	3,254 (12,318)
	48" (1200)	40' (12)	2,982 (11,288)
		60' (18)	4,474 (16,936)
	60" (1500)	40' (12)	4,966 (18,798)
		60' (18)	7,449 (28,198)

\* Rainwater Harvesting units are custom made, therefore no standard product codes are available.



**N-12 Water Harvesting Cistern**



**HP Storm Water Harvesting Cistern**

# Panel Pipe

AdvanEdge®

## Pipe

Pipe Diameter in (mm)	Length ft. (m)	Description	Product Code
12 (300)	100 (30.5)	No Fabric	04900100
		4.0 oz. Spunbond	04930100



## Fittings

Pipe Size in (mm)	Fitting Description	Product Code
12 (300 mm)	Snap End Cap	1432AA
12 (300 mm)	External Split Coupler	1411AA
12 (300 mm)	Wye	1480AA
12 (300 mm)	4" (100 mm) End Outlet	1472AA
12 (300 mm)	Side Outlet	1471AA
4 (100 mm)	12" (300 mm) Flat Outlet	1473AA
12 (300 mm)	Fabricated Tee	1460AN
12 (300 mm)	Fabricated Tee (Horizontal)	1460ANH
12 (300 mm)	Fabricated Tee with Side Outlet	1464ANH
12 (300 mm)	Fabricated Cross Tee	1436ANH
12 (300 mm)	Fabricated Wye	1480AN
12 (300 mm)	Fabricated Wye (Horizontal)	1480ANH
12 (300 mm)	Fabricated Cross Wye	1438ANH



Snap End Cap



External Snap Coupler



Wye



End Outlet



Side Outlet



Flat Outlet



Fabricated Tee

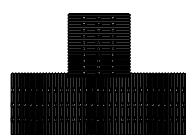

Fabricated Tee (Horizontal)

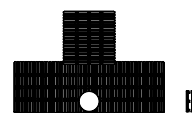

Fabricated Tee with Side Outlet

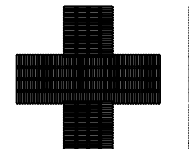

Fabricated Cross Tee



Fabricated Wye

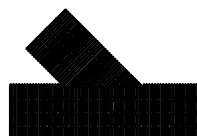

Fabricated Wye Horizontal

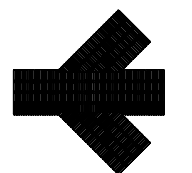

Fabricated Cross Wye

# Stormwater Treatment

## Filters

### BayFilter Stormwater Media Filters

Model	Diameter in (mm)	Treatment Flow Rate gpm (L/sec)	Treatment Volume ft <sup>3</sup> (m <sup>3</sup> )	Filter Surface Area ft <sup>2</sup> (m <sup>2</sup> )	Product Code
BayFilter 522	28" (711)	22.5 (1.42)	1250 (35.4)	45 (4.2)	BAYFLTR-522
BayFilter 530	28" (711)	30 (1.89)	2500 (70.8)	90 (8.4)	BAYFLTR-530
BayFilter 545	28" (711)	45 (2.84)	2500 (70.8)	90 (8.4)	BAYFLTR-545
BayFilter 622	28" (711)	22.5 (1.42)	1250 (35.4)	45 (4.2)	BAYFLTR-622
BayFilter 630	28" (711)	30 (1.89)	2500 (70.8)	90 (8.4)	BAYFLTR-630
BayFilter 645	28" (711)	45 (2.84)	2500 (70.8)	90 (8.4)	BAYFLTR-645



### EcoStream™ BioFilter

Model	Treatment Rate gpm/cfs (L/s)*	Mass Capture Capacity lb (kg)	Sample Configuration
ES16	66/0.147 (4.2)	271 (123)	4 x 4
ES24	99/0.221 (6.3)	407 (185)	4 x 6
ES32	132/0.294 (8.3)	542 (246)	4 x 8
ES40	165/0.368 (10.4)	678 (308)	4 x 10
ES48	198/0.441 (12.5)	813 (369)	4 x 12 or 6 x 8
ES36	149/0.331 (9.4)	610 (277)	6 x 6
ES60	247/0.551 (15.6)	1016 (461)	6 x 10
ES72	297/0.662 (18.7)	1220 (553)	6 x 12
ES80	330/0.735 (20.8)	1355 (615)	8 x 10
ES96	396/0.882 (25.0)	1626 (738)	8 x 12
ES112	462/1.029 (29.1)	1897 (860)	8 x 14
ES128	528/1.176 (33.3)	2168 (983)	8 x 16



\* Based on NJCAT/DEP filtration testing protocol.

### EcoPure BioFilter®

Model	Treatment Rate cfs (L/s)	Mass Capture Capacity lb (kg)
EcoPure 60	0.134 (3.8)	194 (88)
EcoPure 120	0.27 (7.6)	389 (176)
EcoPure 180	0.4 (11.3)	583 (264)
EcoPure 240	0.53 (15.0)	778 (353)
EcoPure 360	0.8 (22.7)	1166 (529)



# Stormwater Treatment

## Separators

### Barracuda Max Stormwater Separator

Model	Manhole Diameter in (mm)	NJDEP (50% removal)	OK-100 (80% removal)
S3	36" (900)	0.85 (24.1)	0.86 (24.1)
S4	48" (1,200)	1.52 (43.0)	1.52 (43.0)
S6	72" (1,800)	3.40 (96.3)	3.42 (96.8)
S8	96" (2,400)	6.08 (172.2)	6.08 (172.2)



### BaySeparator Stormwater Treatment System

Model	Manhole Diameter in (mm)	Manhole Depth ft (m)	Maximum Treatment Rate cfs (L/sec)	Maximum Hydraulic Rate cfs (L/s)	Product Code
BayFilter ½K	48" (1,219)	6' (1.8)	1.1 (31.4)	8.5 (241)	BAYSEP00500
BayFilter 1K	48" (1,219)	8' (2.4)	2.4 (68)	10 (283)	BAYSEP01000
BayFilter 3K	60" (1,524)	8' (2.4)	7.8 (221)	30 (850)	BAYSEP03000
BayFilter 5K	72" (1,829)	8' (2.4)	11.1 (314)	50 (1,416)	BAYSEP05000
BayFilter 10K	120" (3,048)	8' (2.4)	21.8 (617)	100 (2,832)	BAYSEP10000
BayFilter XK	Custom	Custom	Custom	Custom	BAYSYSXK

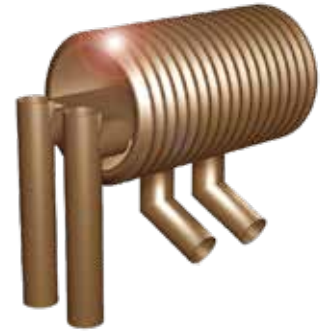

# Stormwater Treatment

## Water Quality Unit

### Water Quality Unit\*

Diameter in (mm)	Length ft. (m)	Inlet Size in (mm)	Outlet Size in (mm)	Treated Flow Rate cfs (L/s)	Product Code
36" (900)	20' (6.0)	10" (250)	10" (250)	1.5 (42)	3620WQA
	40' (12.1)	10" (250)	10" (250)	2.38 (67)	3640WQA
	20' (6.0)	10" (250)	10" (250)	0.7 (20)	3620WQB
	40' (12.1)	10" (250)	10" (250)	1.6 (45)	3640WQB
42" (1050)	20' (6.0)	12" (300)	12" (300)	1.79 (49)	4220WQA
	40' (12.1)	12" (300)	12" (300)	3.66 (104)	4240WQA
	20' (6.0)	12" (300)	12" (300)	0.86 (24)	4220WQB
	40' (12.1)	12" (300)	12" (300)	1.83 (52)	4240WQB
48" (1200)	20' (6.0)	12" (300)	12" (300)	2.26 (64)	4820WQA
	40' (12.1)	12" (300)	12" (300)	3.94 (112)	4840WQA
	20' (6.0)	12" (300)	12" (300)	1.13 (32)	4820WQB
	40' (12.1)	12" (300)	12" (300)	2.39 (68)	4840WQB
60" (1500)	20' (6.0)	15" (375)	15" (375)	2.95 (84)	6020WQA
	40' (12.1)	15" (375)	15" (375)	6.23 (176)	6040WQA
	20' (6.0)	15" (375)	15" (375)	1.47 (42)	6020WQB
	40' (12.1)	15" (375)	15" (375)	3.12 (88)	6040WQB



\* Add two digit number at end of product code for bypass size. 00 at end of product code indicates no bypass.

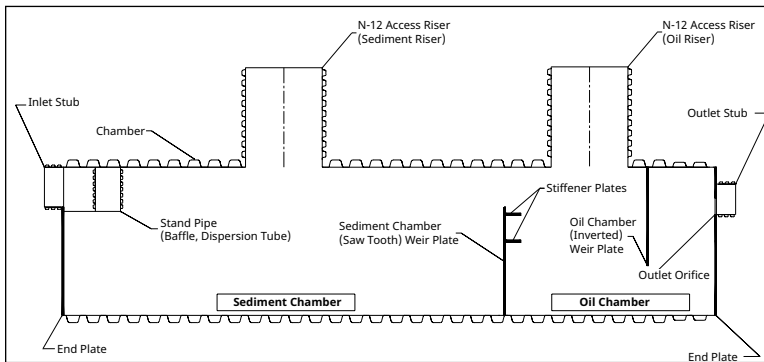



# Stormwater Treatment

## FlexStorm Pure (Permanent) Inlet Filters

### Round

Clear Opening Dimensions	Frame Material	FX Woven Bag	PCP Bag (+ Oil Pouch)
Small (up to 16" diameter openings)	Stainless	62SHDRFX	62SHDRPCP
Medium (up to 24" diameter openings)	Stainless	62MHDRFX	62MHDRPCP
Large (up to 36" diameter openings)	Stainless	62LHDRFX	62LHDRPCP



### Rectangular

Clear Opening Dimensions	Frame Material	FX Woven Bag	PCP Bag (+ Oil Pouch)
Small (up to 16" x 16" openings or 64" perimeter)	Stainless	62SHDFX	62SHDPCP
Medium (up to 24" x 24" openings or 96" perimeter)	Stainless	62MHDFX	62MHDP
Large (up to 36" x 24" openings or 120" perimeter)	Stainless	62LHDFX	62LHDPCP
XLarge (typical 2 piece set to fit up to 48" x 36" opening)	Stainless	62XLHDFX	62XLHDP



### Wall Mount for Open Throat Curb Inlets

Clear Opening Dimensions	Frame Material	FX Woven Bag	PCP Bag (+ Oil Pouch)
Between 1' & 4' curb openings (1 filter & mounting hardware)	Stainless	62HDWM1FX	62HDWM1PCP
Between 4' & 8' or single wing basins (2 filters & mounting hardware)	Stainless	62HDWM2FX	62HDWM2PCP
Between 8' & 12' or double wing basins (3 filters & mounting hardware)	Stainless	62HDWM3FX	62HDWM3PCP
Between 12' & 16' or four-sided basin flow (4 filters & mounting hardware)	Stainless	62HDWM4FX	62HDWM4PCP



### Replacement Bags

Bag Size (Round or Rectangle)	FX Woven Bag	PCP Bag (+ Oil Pouch)
Small	62SRBFX	62SRBPCP
Medium	62MRBFX	62MRBPCP
Large	62LRBFX	62LRBPCP



### Replacement Oil Skimmer Pouches

Product	Product Code
Oil skimmer pouch with swivel hook/strap (20 per box)	62CTSB
Oil skimmer 3" x 34" (75 x 850 mm) for wall mounts (30 per box)	62CTS34



# Stormwater Treatment

## *FlexStorm Lite (Temporary) Inlet Filters*

### Round Inlet Filters with FX Woven Bag

Clear Opening Dimensions	Frame Material	Product Number
Small (up to 16" diameter openings)	Zinc/Galvanized	62LITESRD
Medium (up to 24" diameter openings)	Zinc/Galvanized	62LITEMRD
Large (up to 36" diameter openings)	Zinc/Galvanized	62LITELRD



### Rectangular Inlet Filters with FX Woven Bag

Clear Opening Dimensions	Frame Material	Product Number
Small (up to 16" x 16" openings or 64" perimeter)	Zinc/Galvanized	62LITESSQ
Medium (up to 24" x 24" openings or 96" perimeter)	Zinc/Galvanized	62LITEMSQ
Large (up to 36" x 24" openings or 120" perimeter)	Zinc/Galvanized	62LITELSQ
XLarge (typical 2 piece set to fit up to 48" x 36" opening)	Zinc/Galvanized	62LITEXLSQ



### Rectangular Curb Box with FX Woven Bag

Clear Opening Dimensions	Frame Material	Product Number
Small (up to 16" x 16" openings or 64" perimeter)	Zinc/Galvanized	62LITESCB
Medium (up to 24" x 24" openings or 96" perimeter)	Zinc/Galvanized	62LITEMCB
Large (up to 36" x 24" openings or 120" perimeter)	Zinc/Galvanized	62LITELCB
XLarge (typical 2 piece set to fit up to 48" x 36" opening)	Zinc/Galvanized	62LITEXLCB



# Stormwater Treatment

## FlexStorm Inlet Filters for Nyloplast Basins

### Round Pure (Permanent) Inlet Filters

Round Grate Sizes* in (mm)	FX Woven Bag	PCP Bag (+ Oil Pouch)
12" (300 mm) Nyloplast Casting	6212NYFX	6212NYPCP
15" (375 mm) Nyloplast Casting	6215NYFX	6215NYPCP
18" (450 mm) Nyloplast Casting	6218NYFX	6218NYPCP
24" (600 mm) Nyloplast Casting	6224NYFX	6224NYPCP
30" (750 mm) Nyloplast Casting	6230NYFX	6230NYPCP



### Round Lite (Temporary) Inlet Filters

Round Grate Sizes* in (mm)	Product Number
12" (300 mm) Nyloplast Casting	62LITENY12
15" (375 mm) Nyloplast Casting	62LITENY15
18" (450 mm) Nyloplast Casting	62LITENY18
24" (600 mm) Nyloplast Casting	62LITENY24
30" (750 mm) Nyloplast Casting	62LITENY30



\* ADS Inlet Filter framing is designed for standard and pedestrian grate castings. Dome Grates and Drop-In Grates require special hanger kit. When ordering for rectangular road and highway or curb inlets, the filters will sit in the base plate of the castings. Some of these base castings require a transition plate to adapt to the standard 12"-18" (300-450 mm) diameter ADS Inlet Filters. ADS customer service will identify the proper transition plates, which will ship with the inlet filter.

### Maintenance Tool

Product	Product Code
ADS Maintenance & Grate Removal Tool	62UMT



# Linear Drains

## Duraslot Slot Drain

### Pipe

Pipe Diameter in (mm)	Slot Height in (mm)	Product Code	
		Galvanized Grate*	Open Top Grate**
4" (100)	2.5" (64)	0420DS	0420DSOT
	6" (150)	0460DS	0460DSOT
	Variable (up to 24" (600) tall slot)	0490DS	0490DSOT
6" (150)	2.5" (64)	0620DS	0620DSOT
	6" (150)	0660DS	0660DSOT
	Variable (up to 24" (600) tall slot)	0690DS	0690DSOT
8" (200)	2.5" (64)	0820DS	0820DSOT
	6" (150)	0860DS	0860DSOT
	Variable (up to 24" (600) tall slot)	0890DS	0890DSOT
10" (250)	2.5" (64)	1020DS	1020DSOT
	6" (150)	1060DS	1060DSOT
	Variable (up to 24" (600) tall slot)	1090DS	1090DSOT
12" (300)	2.5" (64)	1220DS	1220DSOT
	6" (150)	1260DS	1260DSOT
	Variable (up to 24" (600) tall slot)	1290DS	1290DSOT
	Variable (24"-36" (600-900) tall slot)	1290DSDT	1290DSDTOT
15" (375)	6" (150)	1560DS	1560DSOT
	Variable (up to 24" (600) tall slot)	1590DS	1590DSOT
	Variable (24"-36" (600-900) tall slot)	1590DSDT	1590DSDTOT
18" (450)	6" (150)	1860DS	1860DSOT
	Variable (up to 24" (600) tall slot)	1890DS	1890DSOT
	Variable (24"-36" (600-900) tall slot)	1890DSDT	1890DSDTOT
24" (600)	6" (150)	2460DS	2460DSOT
	Variable (up to 24" (600) tall slot)	2490DS	2490DSOT
	Variable (24"-36" (600-900) tall slot)	2490DSDT	2490DSDTOT
30" (750)	6" (150)	3060DS	3060DSOT
	Variable (up to 24" (600) tall slot)	3090DS	3090DSOT
	Variable (24"-36" (600-900) tall slot)	3090DSDT	3090DSDTOT
36" (900)	6" (150)	3660DS	3660DSOT
	Variable (up to 24" (600) tall slot)	3690DS	3690DSOT
	Variable(24"-36" (600-900) tall slot)	3690DSDT	3690DSDTOT

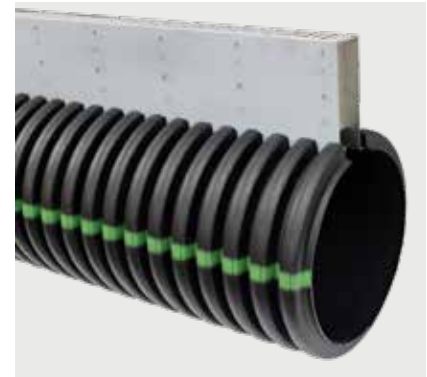

\* Galvanized grate is ADS compliant and heel proof with 64% open area. Applications include: public street and highway, airports, loading docks, athletic facilities, parking lots and industrial floors.

\*\*Open top is no grate with 1¾" opening with 100% open area. Applications include: public street and highway.

# Linear Drains

## Duraslot Slot Drain

### Couplers\*

Pipe Diameter in (mm)	Fitting Compatible with Product Code	Product Code
4" (100)	0420DS	0421DS
	0460DS	0426DS
	0490DS	0491DS
6" (150)	0620DS	0621DS
	0660DS	0626DS
	0690DS	0691DS
8" (200)	0820DS	0821DS
	0860DS	0821DS
	0890DS	0891DS
10" (250)	1020DS	1021DS
	1060DS	1026DS
	1090DS	1091DS
12" (300)	1220DS	1221DS
	1260DS	1226DS
	1290DS/1290DSDT	1291DS
15" (375)	1560DS	1526DS
	1590DS/1590DSDT	1591DS
18" (450)	1860DS	1826DS
	1890DS/1890DSDT	1891DS
24" (600)	2460DS	2426DS
	2490DS/2490DSDT	2491DS
30" (750)	3060DS	3026DS
	3090DS/3090DSDT	3091DS
36" (900)	3660DS	3626DS
	3690DS/3690DSDT	3691DS



\* Coupler is needed for every Duraslot to Duraslot pipe or fabricated fitting connection.

ADS produces Duraslot elbows with typical bends (11.25°, 22.5°, 45° and 90°). Tees are available as mainline tees (slot across the mainline's top), drop tees (stub faces downward) or three branch slot (slot on all three branches). All elbows and tees use part #990DS, but please indicate pipe diameter and indicate the elbow or tee needed in the description.

# Linear Drains

## Duraslot Slot Drain

### End Caps

Pipe Diameter in (mm)	Fitting Compatible with Product Code	Product Code
4" (100)	0420DS/0460DS	0433DS
	0490DS	0493DS
6" (150)	0620DS/0660DS	0633DS
	0690DS	0693DS
8" (200)	0820DS/0860DS	0833DS
	0890DS	0893DS
10" (250)	1020DS/1060DS	1033DS
	1090DS	1093DS
12" (300)	1220DS/1260DS	1233DS
	1290DS/1290DSDT	1293DS
15" (375)	1560DS	1533DS
	1590DS/1590DSDT	1593DS
18" (450)	1860DS	1833DS
	1890DS/1890DSDT	1893DS
24" (600)	2460DS	2433DS
	2490DS/2490DSDT	2493DS
30" (750)	3060DS	3033DS
	3090DS/3090DSDT	3093DS
36" (900)	3660DS	3633DS
	3690DS/3690DSDT	3693DS



### Adapters

Pipe Diameter in (mm)	Fitting Compatible with Product Code	Product Code
4" (100)	0420DS/0460DS	0462DS
	0490DS	0496DS
6" (150)	0620DS/0660DS	0662DS
	0690DS	0696DS
8" (200)	0820DS/0860DS	0862DS
	0890DS	0896DS
10" (250)	1020DS/1060DS	1062DS
	1090DS	1096DS
12" (300)	1220DS/1260DS	1262DS
	1290DS/1290DSDT	1296DS
15" (375)	1560DS	1562DS
	1590DS/1590DSDT	1596DS
18" (450)	1860DS	1862DS
	1890DS/1890DSDT	1896DS
24" (600)	2460DS	2462DS
	2490DS/2490DSDT	2496DS
30" (750)	3060DS	3062DS
	3090DS/3090DSDT	3096DS
36" (900)	3660DS	3662DS
	3690DS/3690DSDT	3696DS



\* Adapter is needed to transition from Duraslot to N-12, HP Storm and any concrete structure.

# Linear Drains

## Duraslot Slot Drain

### Nyloplast Tee for Duraslot Clean Out\*

Product Description in (mm)	Product Code
12" (300) Tee with 12" (300) Solid Cover	1265AGDS
15" (375) Tee with 12" (300) Solid Cover	1565AGDS
18" (450) Tee with 12" (300) Solid Cover	1865AGDS
24" (600) Tee with 12" (300) Solid Cover	2465AGDS



### Nyloplast Basin for Duraslot Clean Out\*

Product Description in (mm)	Product Code
12" (300) Basin with 12" (300) Solid Cover	2812AG3
15" (375) Basin with 12" (300) Solid Cover	2815AG3
18" (450) Basin with 12" (300) Solid Cover	2818AG3
24" (600) Basin with 12" (300) Solid Cover	2824AG3



### Duraslot Grate Anchors

Product Description in (mm)	Product Code
For 4" (100) Duraslot with 2.5" (64) Slot Height	GASDS
For 6"-12" (150-300) Duraslot with 2.5" (64) Slot Height	GAMDS
For 4"-36" (100-900) Duraslot with 6" (150) Slot Height	GALDS

\* For each Duraslot to Nyloplast connection, please quote a grate anchor.

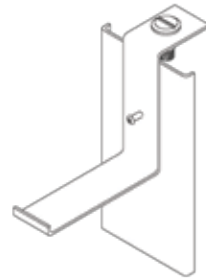



# Linear Drains

## Duraslot XL Trench Drain

### Pipe

Diameter in (mm)	Slot Height in (mm)	Product Code
6" (150)	2.5" (64)	0620DSXL
	6" (150)	0660DSXL
	Variable (up to 24" (600) tall slot)	0690DSXL
8" (200)	2.5" (64)	0820DSXL
	6" (150)	0860DSXL
	Variable (up to 24" (600) tall slot)	0890DSXL
10" (250)	2.5" (64)	1020DSXL
	6" (150)	1060DSXL
	Variable (up to 24" (600) tall slot)	1090DSXL
12" (300)	2.5" (64)	1220DSXL
	6" (150)	1260DSXL
	Variable (up to 24" (600) tall slot)	1290DSXL
	Variable (24"-36" (600-900) tall slot)	1290DSDTXL
15" (375)	6" (150)	1560DSXL
	Variable (up to 24" (600) tall slot)	1590DSXL
	Variable (24"-36" (600-900) tall slot)	1590DSDTXL
18" (450)	6" (150)	1860DSXL
	Variable (up to 24" (600) tall slot)	1890DSXL
	Variable (24"-36" (600-900) tall slot)	1890DSDTXL
24" (600)	6" (150)	2460DSXL
	Variable (up to 24" (600) tall slot)	2490DSXL
	Variable (24"-36" (600-900) tall slot)	2490DSDTXL
30" (750)	6" (150)	3060DS
	Variable (up to 24" (600) tall slot)	3090DSXL
	Variable (24"-36" (600-900) tall slot)	3090DSDTXL
36" (900)	6" (150)	3660DSXL
	Variable (up to 24" (600) tall slot)	3690DSXL
	Variable(24"-36" (600-900) tall slot)	3690DSDTXL





# Linear Drains

## Duraslot XL Trench Drain

### Grates

Grate Type	Product Code
Standard	0520XLDIS
Pedestrian	0520XLDIW

\* Grates fit all diameters of Duraslot XL pipe.



Standard Grate



Pedestrian Grate

### Couplers\*\*

Pipe Diameter in (mm)	Fitting Compatible with Product Code	Product Code
6" (150)	0620DSXL/0660DSXL/0690DSXL	0691DSXL
8" (200)	0820DSXL/0860DSXL/0890DSXL	0891DSXL
10" (250)	1020DSXL/1060DSXL/1090DSXL	1091DSXL
12" (300)	1220DSXL/1260DSXL/ 1290DSXL	1291DSXL
15" (375)	1560DSXL/1590DSXL	1591DSXL
18" (450)	1860DSXL/1890DSXL	1891DSXL
24" (600)	2460DSXL/2490DSXL	2491DSXL
30" (750)	3060DSXL/3090DSXL	3091DSXL
36" (900)	3660DSXL/3690DSXL	3691DSXL



\*\* Coupler is needed for every Duraslot to Duraslot pipe or fabricated fitting connection.

ADS produces Duraslot elbows with typical bends (11.25°, 22.5°, 45° and 90°). Tees are available as mainline tees (slot across the mainline's top), drop tees (stub faces downward) or three branch slot (slot on all three branches). All elbows and tees use part #990DS, but please indicate pipe diameter and indicate the elbow or tee needed in the description.

# Linear Drains

## Duraslot XL Trench Drain

### End Caps

Pipe Diameter in (mm)	Fitting Compatible with Product Code	Product Code
6" (150)	0620DSXL/0660DSXL	0633DSXL
	0690DSXL	0693DSXL
8" (200)	0820DSXL/0860DSXL	0833DSXL
	0890DSXL	0893DSXL
10" (250)	1020DSXL/1060DSXL	1033DSXL
	1090DSXL	1093DSXL
12" (300)	1220DSXL/1260DSXL	1233DSXL
	1290DSXL	1293DSXL
15" (375)	1560DSXL	1533DSXL
	1590DSXL	1593DSXL
18" (450)	1860DSXL	1833DSXL
	1890DSXL	1893DSXL
24" (600)	2460DSXL	2433DSXL
	2490DSXL	2493DSXL
30" (750)	3060DSXL	3033DSXL
	3090DSXL	3093DSXL
36" (900)	3660DSXL	3633DSXL
	3690DSXL	3693DSXL



### Adapters

Pipe Diameter in (mm)	Fitting Compatible with Product Code	Product Code
6" (150)	0620DSXL/0660DSXL	0662DSXL
	0690DSXL	0696DSXL
8" (200)	0820DSXL/0860DSXL	0862DSXL
	0890DSXL	0896DSXL
10" (250)	1020DSXL/1060DSXL	1062DSXL
	1090DSXL	1096DSXL
12" (300)	1220DSXL/1260DSXL	1262DSXL
	1290DSXL	1296DSXL
15" (375)	1560DSXL	1562DSXL
	1590DSXL	1596DSXL
18" (450)	1860DSXL	1862DSXL
	1890DSXL	1896DSXL
24" (600)	2460DSXL	2462DSXL
	2490DSXL	2496DSXL
30" (750)	3060DSXL	3062DSXL
	3090DSXL	3096DSXL
36" (900)	3660DSXL	3662DSXL
	3690DSXL	3696DSXL



\* Adapter is needed to transition from Duraslot to N-12, HP Storm and any concrete structure.

# Onsite Wastewater Systems

## Arc & Biodiffuser Chambers & Accessories

### Arc Chambers\*



Arc 18



Arc 24



Arc 36



Arc 36HC



Arc 36LP

Type	Dimensions L x W x H in (mm)	Capacity ft <sup>3</sup> (m <sup>3</sup> )	Product Code
Arc 18	67" x 16" x 12" (1,702 x 406 x 300)	3.42 (0.10)	1812BD
Arc 24	67" x 22.5" x 12" (1,702 x 572 x 300)	5.02 (0.14)	2412BD
Arc 36	63" x 34.5" x 13" (1,600 x 876 x 330)	8.0 (0.23)	3613BD3
Arc 36HC	63" x 34.5" x 16" (1,600 x 876 x 400)	10.7 (0.30)	3616BD3
Arc 36LP	63" x 34" x 8" (1,600 x 864 x 200)	5.84 (0.17)	3608BD

\* All Arc chambers have a load rating of H-10.

### Arc End Caps, Port Couplers, Splash Plate



End Cap



Side Port Coupler

Type	Product Code
Arc 18 End Cap	1802BD
Arc 24 End Cap	2402BD
Arc 36 End Cap	3603BD2
Arc 36HC End Cap	3606BD3
Arc 36LP End Cap	3624LPEC
Arc 24 Side Port Coupler	2403BD
Arc 36 Side Port Coupler	3604BD
Arc 36HC Side Port Coupler	3607BD
End Cap Splash Plate	0068

# Onsite Wastewater Systems

## Biodiffuser Chambers/Accessories & Septic Stack

### Biodiffuser Chambers



1600BD



1620BD

Type in (mm)	Load Rating	Dimensions L x W x H in (mm)	Capacity ft <sup>3</sup> (m <sup>3</sup> )	Product Code
16" (400) Hi Capacity	H-10	76" x 34" x 16" (1,930 x 863 x 400)	13.6 (0.39)	1600BD
16" (400) Hi Capacity	H-20	76" x 34" x 16" (1,930 x 863 x 400)	13.6 (0.39)	1620BD

### Biodiffuser End Caps, Angle Section



1601BD



1622BD

Type in (mm)	Product Code
16" (400) End Cap	1601BD
16" (400) Angle Section 0-22°	1622BD

### Septic Stack Systems



9 Pipe Septic Stack

Description in (mm)	Nominal Length ft (m)	Product Code
4" (100) Perforated 9 Pipe	10' (3)	04710090
4" (100) Perforated 11 Pipe	10' (3)	04710110
4" (100) Perforated 13 Pipe	10' (3)	04710130
3611 System of 4" (100) Perforated Pipe	10' (3)	04710110
3613 System of 4" (100) Perforated Pipe	10' (3)	04710130

# Onsite Wastewater Systems

## Accessories

### Distribution Boxes

Description	Product Code
Multi-Purpose Regular Distribution Box	1369AB
Multi-Purpose Hillside Distribution Box	1370AB
Regular Distribution Box Plug	1379AB
Hillside Distribution Box Plug	1380AB



1369AB



1370AB

### Bull Run Valve



Description in (mm)	Product Code
Bull Run Valve with 24" (600) Key	4182FG



### Sewage Ejector Sump

Description in (mm)	Product Code
Lid Kit for Sewage Ejector Sump and Radon Vented Sump	1530ADLX



# Foundation Drainage

## Sump Liners & Lids; Waterstop Gaskets

### Sump Liner

Description gal (L)	Dimensions in (mm)	Product Code
14 gal (53) Sump Liner	18" x 24" (450 x 600)	1524ADH
19 gal (72) Locking Sump Liner	18" x 30" (450 x 750)	1530ADH
14 gal (53) Radon Dual Purpose Vented Liner	18" x 24" (450 x 600)	1524ADR



1524ADH



1530ADH



1524ADR

### Sump Liner Lid

Description	Dimensions in (mm)	Product Code
Solid, Locking	18" (450)	1537ADL
Notched, Locking	18" (450)	1537ADNL
Center Notched, Locking	18" (450)	1537ADCNL



1537ADL



1537ADNL



1537ADCNL

### Waterstop Gaskets

Pipe Size in (mm)	Recommended Minimum Hole Diameter in (mm)	Minimum Distance Pipe Invert to Structure Invert in (mm)	Product Code
12" (300)	19.50" (495)	3.7 (94)	1202PS
15" (375)	23.00" (584)	4.0" (102)	1502PS
18" (450)	26.50" (673)	4.2" (107)	1802PS
24" (600)	33.25" (845)	4.5" (114)	2402PS
30" (750)	40.50" (1,029)	5.2" (132)	3002PS
36" (900)	47.00" (1,194)	5.5" (140)	3602PS
42" (1050)	53.00" (1,346)	5.75" (146)	4202PS
48" (1200)	59.00" (1,499)	5.75" (146)	4802PS
54" (1350)*	65.00" (1,651)	6.4" (163)	5402PS
60" (1500)	72.00" (1,829)	6.4" (163)	6002PS



\* Limited Geographic Availability.

# Geosynthetics

## Nonwoven

### Light Weight Civil



Weight oz (g)	Size width x length ft (m)	Roll Size y <sup>2</sup> (m <sup>2</sup> )	Product Code
3.0 (85)	3.0' x 360' (0.91 x 109.7)	120 (100)	0311TA
	4.0' x 360' (1.2 x 109.7)	160 (134)	0311TB
	5.0' x 360' (1.5 x 109.7)	200 (167)	0311TD
	6.3' x 360' (1.9 x 109.7)	250 (209)	0311TF
	7.5' x 360' (2.3 x 109.7)	300 (251)	0311TT
	12.5' x 360' (3.8 x 109.7)	500 (418)	0311TG
	15.0' x 360' (4.6 x 109.7)	600 (502)	0311TS
3.5 (99)	3.0' x 360' (0.91 x 109.7)	120 (100)	0351TA
	4.0' x 360' (1.2 x 109.7)	160 (134)	0351TB
	5.0' x 360' (1.5 x 109.7)	200 (167)	0351TD
	6.3' x 360' (1.9 x 109.7)	250 (209)	0351TF
	7.5' x 360' (2.3 x 109.7)	300 (251)	0351TT
	12.5' x 360' (3.8 x 109.7)	500 (418)	0351TG
	15.0' x 360' (4.6 x 109.7)	600 (502)	0351TS
4.0 (113)	3.0' x 360' (0.91 x 109.7)	120 (100)	0401TA
	4.0' x 360' (1.2 x 109.7)	160 (134)	0401TB
	5.0' x 360' (1.5 x 109.7)	200 (167)	0401TD
	6.3' x 360' (1.9 x 109.7)	250 (209)	0401TF
	7.5' x 360' (2.3 x 109.7)	300 (251)	0401TT
	12.5' x 360' (3.8 x 109.7)	500 (418)	0401TG
	15.0' x 360' (4.6 x 109.7)	600 (502)	0401TS
4.5 (128)	3.0' x 360' (0.91 x 109.7)	120 (100)	0451TA
	4.0' x 360' (1.2 x 109.7)	160 (134)	0451TB
	5.0' x 360' (1.5 x 109.7)	200 (167)	0451TD
	6.3' x 360' (1.9 x 109.7)	250 (209)	0451TF
	7.5' x 360' (2.3 x 109.7)	300 (251)	0451TT
	12.5' x 360' (3.8 x 109.7)	500 (418)	0451TG
	15.0' x 360' (4.6 x 109.7)	600 (502)	0451TS
5.0 (141)	12.5' x 360' (3.8 x 109.7)	500 (418)	0551TG
	15.0' x 360' (4.6 x 109.7)	600 (502)	0551TS



# Geosynthetics

## Nonwoven

### Medium Weight Civil



Weight oz (g)	Size width x length ft (m)	Roll Size y <sup>2</sup> (m <sup>2</sup> )	Product Code
6.0 (170)	3.0' x 360' (0.91 x 109.7)	120 (100)	0601TA
	4.0' x 360' (1.2 x 109.7)	160 (134)	0601TB
	5.0' x 360' (1.5 x 109.7)	200 (167)	0601TD
	6.3' x 360' (1.9 x 109.7)	250 (209)	0601TF
	7.5' x 360' (2.3 x 109.7)	300 (251)	0601TT
	12.5' x 360' (3.8 x 109.7)	500 (418)	0601TG
	15.0' x 300' (4.6 x 91.4)	500 (418)	0601TS
7.0 (198)	3.0' x 360' (0.91 x 109.7)	120 (100)	0701TA
	4.0' x 360' (1.2 x 109.7)	160 (134)	0701TB
	5.0' x 360' (1.5 x 109.7)	200 (167)	0701TD
	6.3' x 360' (1.9 x 109.7)	250 (209)	0701TF
	7.5' x 360' (2.3 x 109.7)	300 (251)	0701TT
	12.5' x 360' (3.8 x 109.7)	500 (418)	0701TG
	15.0' x 300' (4.6 x 91.4)	500 (418)	0701TS
8.0 (227)	12.5' x 360' (3.8 x 109.7)	500 (418)	0801TG
	15.0' x 300' (4.6 x 91.4)	500 (418)	0801TS



### Heavy Weight



Weight oz (g)	Size width x length ft (m)	Roll Size y <sup>2</sup> (m <sup>2</sup> )	Product Code
10.0 (283)	15.0' x 300' (4.6 x 91.4)	500 (418)	1001TS
12.0 (340)	15.0' x 300' (4.6 x 91.4)	500 (418)	1201TS
16.0 (454)	15.0' x 300' (4.6 x 91.4)	500 (418)	1601TS

### Environmental



Weight oz (g)	Size width x length ft (m)	Roll Size y <sup>2</sup> (m <sup>2</sup> )	Product Code
6.5 (184)	15.0' x 900' (4.6 x 274)	1,500 (1254)	0651TS
8.0 (227)	15.0' x 690' (4.6 x 210)	1,150 (962)	0861TS
10.0 (283)	15.0' x 300' (4.6 x 91.4)	500 (418)	1071TS
12.0 (340)	15.0' x 480' (4.6 x 146)	800 (669)	1291TS
17.0 (482)	15.0' x 360' (4.6 x 110)	600 (502)	1701TS



# Geosynthetics

## Woven

### Stabilization



Grab Tensile	Size width x length ft (m)	Roll Size y <sup>2</sup> (m <sup>2</sup> )	Product Code
200	12.5' x 432' (3.8 x 131.7)	600 (502)	200WTK
	15.0' x 360' (4.6 x 109.7)	600 (502)	200WTS
	17.5' x 309' (5.3 X 94.2)	600 (502)	200WTM
250	12.5' x 360' (3.8 X 109.7)	500 (418)	250WTK
	15.0' x 360' (4.6 x 109.7)	600 (502)	250WTS
	17.5' x 258' (5.3 X 78.6)	500 (418)	250WTM
270	12.5' x 360' (3.8 X 109.7)	500 (418)	270WTK
	15' x 300' (4.6 X 91.4)	500 (418)	270WTS
	17.5' x 258' (5.3 x 78.6)	500 (418)	270WTM
315	12.5' x 360' (3.8 X 109.7)	500 (418)	315WTK
	15' x 300' (4.6 X 91.4)	500 (418)	315WTS
	17.5' x 258' (5.3 x 78.6)	500 (418)	315WTM
	12.5' x 360' (3.8 X 109.7)	500 (418)	315WTK

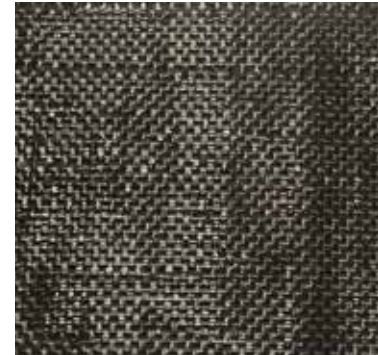

### Monofilament



Size width x length ft (m)	Roll Size y <sup>2</sup> (m <sup>2</sup> )	Product Code
12.0' x 300' (3.6 x 91.4)	400 (334)	104FWF
12.5' x 300' (3.8 x 91.4)	417 (348)	111FTK
12.0' x 300' (3.6 x 91.4)	400 (334)	117FTK

### Medium



Size width x length ft (m)	Roll Size y <sup>2</sup> (m <sup>2</sup> )	Product Code
15.0' x 300' (4.6 x 91.4)	500 (418)	2x2
15.0' x 300' (4.6 x 91.4)	500 (418)	270HPTS
17.0' x 258' (5.3 x 78.6)	500 (418)	270HPTM
17.5' x 257' (5.3 x 78.3)	500 (418)	370HPTS
15.0' x 300' (4.6 x 91.4)	500 (418)	570HPTS

# Geosynthetics

## Geogrid, Paving Fabric & Silt Fence

### Biaxial



Size width x length ft (m)	Roll Size y <sup>2</sup> (m <sup>2</sup> )	Product Code
12.5' x 328' (3.8 x 100)	455 (380)	BX114
12.5' x 246' (3.8 x 75)	342 (286)	BX124
12.5' x 328' (3.8 x 100)	455 (380)	BX224
12.5' x 164' (3.8 x 50)	228 (190)	BX154
12.5' x 164' (3.8 x 50)	228 (190)	BX150
12.5' x 328' (3.8 x 100)	455 (380)	BX1515
12.5' x 164' (3.8 x 50)	228 (190)	BX374

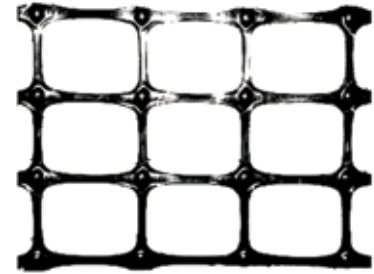

### Paving Fabric



Size width x length ft (m)	Roll Size y <sup>2</sup> (m <sup>2</sup> )	Product Code
12.5' x 360' (3.8 x 109.7)	500 (418)	4598TG
15.0' x 360' (4.6 x 109.7)	600 (502)	4598TS
12.5' x 360' (3.8 x 109.7)	500 (418)	4599TG
15.0' x 360' (4.6 x 109.7)	600 (502)	4599TS



### Silt Fence



Description ft (m)	Product Code
2' x 100' (.6 x 30) roll with 11 hardwood stakes	3301WE
3' x 100' (.9 x 30) roll with 11 hardwood stakes	3302WE
3' x 100' (.9 x 30) AASHTO M288 Silt Fence with 17 hardwood stakes	3302WP



3301WE



3301WP

# Geosynthetics

## Erosion Control Blankets, Turf Reinforcement Mat, Ground Protection

### Erosion Control Blanket



Size width x length ft (m)	Roll Size y <sup>2</sup> (m <sup>2</sup> )	Description	Product Code
8' x 112.5' (2.4 x 34.3)	100 (84)	Single Net Straw	OOS1TT
8' x 112.5' (2.4 x 34.3)	100 (84)	Double Net Straw	OOS2TT
8' x 112.5' (2.4 x 34.3)	100 (84)	Coconut/Straw	OCS2TT
8' x 112.5' (2.4 x 34.3)	100 (84)	100% Coconut	OOC2TT
8' x 112.5' (2.4 x 34.3)	100 (84)	Single net straw all natural	OOS1AN
8' x 112.5' (2.4 x 34.3)	100 (84)	Double net straw all natural	OOS2AN
8' x 112.5' (2.4 x 34.3)	100 (84)	Coconut/Straw all natural	OCS2AN
8' x 112.5' (2.4 x 34.3)	100 (84)	100% Coconut all natural	OOC2AN



OOS1TT,  
OOS2TT



OOC2TT

### Long-Term Turf Reinforcement Mat



Size width x length ft (m)	Roll Size y <sup>2</sup> (m <sup>2</sup> )	Product Code
8' x 112' (2.4 x 34.1)	100 (84)	PP58GTR
8' x 112' (2.4 x 34.1)	100 (84)	PP510GTR
8' x 112' (2.4 x 34.1)	100 (84)	PP512GTR



### Permanent Turf Reinforcement Mat



Size width x length ft (m)	Roll Size y <sup>2</sup> (m <sup>2</sup> )	Product Code
8' x 135' (2.4 x 41)	120 (100)	PP5XGTR
8' x 135' (2.4 x 41)	120 (100)	PP5HDGTR



### Fabric Pins



Size in (mm)	Quantity	Product Code
6" (50) Staple	1000/box	3206TP
12" (300) Pin	100/box	3212TP
18" (450) Pin	100/box	3218TP



### Ground Protection Mat



Size width x length ft (m)	Product Code
2' x 8' (0.6 x 2.4)	BAM28
4' x 8' (1.2 x 2.4)	BAM48



Pedestrian Side



Equipment Side

# Geosynthetics

## Septic Fabric

### Spunbond



Weight oz. (g)	Size width x length ft (m)	Roll Size y <sup>2</sup> (m <sup>2</sup> )	Product Code
1.5 (43)	3.0' x 300' (.9 x 91.4)	100 (84)	3151TA
	4.0' x 300' (1.2 x 91.4)	133 (111)	3151TB
	6.3' x 300' (1.9 x 91.4)	208 (174)	3151TE
	12.6' x 300' (3.8 x 91.4)	420 (351)	3151TG
2.0 (57)	3.0' x 300' (.9 x 91.4)	100 (84)	3201TA
	6.3' x 300' (1.9 x 91.4)	208 (174)	3201TE
	4.0' x 300' (1.2 x 91.4)	133 (111)	3201TB
	12.6' x 300' (3.8 x 91.4)	420 (351)	3201TG
3.0 (85)	3.0' x 300' (.9 x 91.4)	100 (84)	3301TA
	4.0' x 300' (1.2 x 91.4)	133 (111)	3301TB
	6.3' x 300' (1.9 x 91.4)	208 (174)	3301TE
	9.0' x 300' (2.7 x 91.4)	300 (247)	3301TT
	12.6' x 300' (3.8 x 91.4)	420 (351)	3301TG
4.0 (113)	12.6' x 300' (3.8 x 91.4)	420 (351)	3401TG
	15.6' x 300' (4.8 x 91.4)	520 (435)	3401TH
6.0 (170)	3.8' x 300' (1.2 x 91)	420 (351)	3601TG
	15.6' x 300' (4.8 x 91)	520 (435)	3601TH

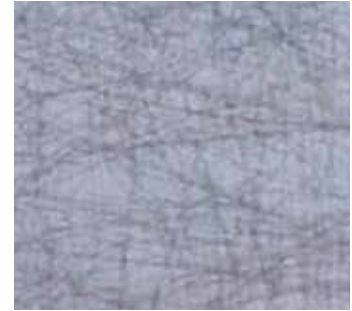

### Septic Fabric



Weight oz. (g)	Size width x length ft (m)	Roll Size y <sup>2</sup> (m <sup>2</sup> )	Product Code
0.5 (14)	3.0' x 300' (.9 x 91.4)	100 (84)	2636RB
	3.0' x 1500' (.9 x 457.2)	500 (418)	2736RB
	4.0' x 1500' (1.2 x 457.2)	667 (558)	2748RB
	5.0' x 1500' (1.5 x 457.2)	833 (696)	2760RB
	6.0' x 1500' (1.8 x 457.2)	1,000 (836)	2772RB
0.7 (20)	3.0' x 300' (.9 x 91.4)	100 (84)	2836RB
	3.0' x 1500' (.9 x 457.2)	500 (418)	2936RB
	4.0' x 1500' (1.2 x 457.2)	667 (558)	2948RB
	6.0' x 1500' (1.8 x 457.2)	1,000 (836)	2972RB







ADS "Terms and Conditions of Sale" are available on the ADS website, [www.adspipe.com](http://www.adspipe.com).  
Advanced Drainage Systems, the ADS logo, the Green Stripe, ADS 3000 TripleWall®, Duraslot®, N-12®, Grain Aire®, SaniTite® HP, MEGA GREEN™, Channel-Flow®, Bend-A-Drain™ and ADS PolyFlex™ are registered trademarks of Advanced Drainage Systems, Inc. Flexstorm® and Catch-It® are registered trademarks of Inlet & Pipe Protection, Inc. StormTech® is a registered trademark of StormTech, Inc. Inserta Tee® is a registered trademark of Inserta Fittings, Inc. Nyloplast® and EnviroHood™ are registered trademarks of Nyloplast, Inc. Arc™ and Biodiffuser® are registered trademarks of ISL. Hickenbottom® is a registered trademark of Hickenbottom, Inc. Mar Mac® is a registered trademark of Mar Mac Construction Products Co., Inc.  
© 2024 Advanced Drainage Systems, Inc. #10524 12/24 MH

[adspipe.com](http://adspipe.com)

800-821-6710

**///ADS**  
Advanced Drainage Systems, Inc.