

# 30 \_\_ AGR \_\_ X

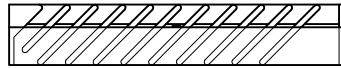

LEFT FLOW ROLL CURB HOOD

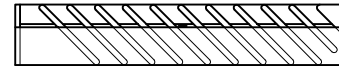

RIGHT FLOW ROLL CURB HOOD

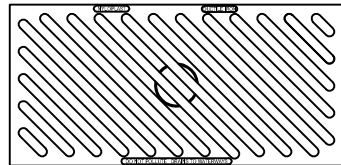

2'X3' DIAGONAL GRATE

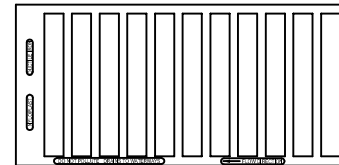

2'X3' HIGH FLOW GRATE

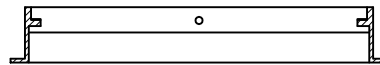

FRAME



24" BASE PLATE

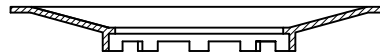

18" BASE PLATE



30" BASE PLATE

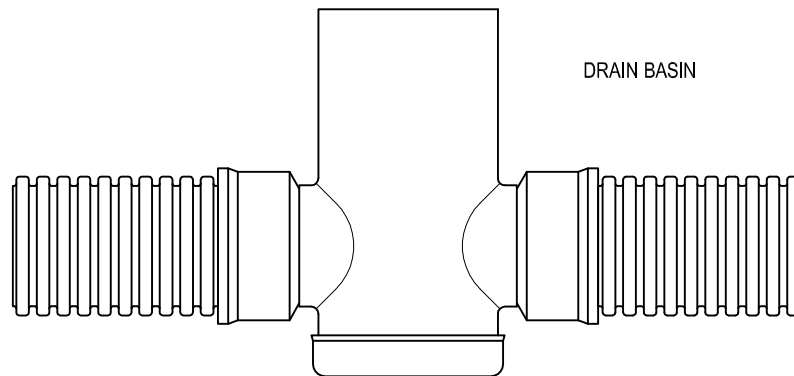

DRAIN BASIN

THIS PRINT DISCLOSES SUBJECT MATTER IN WHICH NYLOPLAST HAS PROPRIETARY RIGHTS. THE RECEIPT OR POSSESSION OF THIS PRINT DOES NOT CONFER, TRANSFER, OR LICENSE THE USE OF THE DESIGN OR TECHNICAL INFORMATION SHOWN HEREIN REPRODUCTION OF THIS PRINT OR ANY INFORMATION CONTAINED HEREIN, OR MANUFACTURE OF ANY ARTICLE HEREFROM, FOR THE DISCLOSURE TO OTHERS IS FORBIDDEN, EXCEPT BY SPECIFIC WRITTEN PERMISSION FROM NYLOPLAST.

©2013 NYLOPLAST

DRAWN BY	CJA	MATERIAL		
DATE	02-28-03	PROJECT NO./NAME		
REVISED BY	CCA	SCALE	1:20	SHEET 1 OF 1
DATE	09-03-13	DWG NO.	7002-110-023	REV E
DWG SIZE	A			



3130 VERONA AVE  
 BUFORD, GA 30518  
 PHN (770) 932-2443  
 FAX (770) 932-2490  
[www.nyloplast-us.com](http://www.nyloplast-us.com)

---

TITLE

2 FT X 3 FT ROLL CURB INLET FAMILY