

DUAL WALL FABRICATED 60° REDUCING WYES
36"×4" - 36"×10" DIAMETER

PART #	PIPE SIZE	A	B	C	JOINT
3680AN60	36 x 4 in (900 x 100 mm)	52.5 in (1334 mm)	30.0 in (762 mm)	38.3 in (972 mm)	*
3680AN6065B	36 x 4 in (900 x 100 mm)	42.0 in (1067 mm)	29.4 in (745 mm)	33.0 in (839 mm)	WT
3681AN60	36 x 6 in (900 x 150 mm)	52.5 in (1334 mm)	31.0 in (787 mm)	38.3 in (972 mm)	*
3681AN6065B	36 x 6 in (900 x 150 mm)	42.0 in (1067 mm)	30.2 in (768 mm)	33.0 in (839 mm)	WT
3682AN60	36 x 8 in (900 x 200 mm)	57.8 in (1467 mm)	32.7 in (831 mm)	40.9 in (1039 mm)	*
3682AN6065B	36 x 8 in (900 x 200 mm)	47.3 in (1200 mm)	31.8 in (806 mm)	35.7 in (906 mm)	WT
3683AN60	36 x 10 in (900 x 250 mm)	57.8 in (1467 mm)	35.4 in (899 mm)	40.9 in (1039 mm)	*
3683AN6065B	36 x 10 in (900 x 250 mm)	47.3 in (1200 mm)	34.2 in (867 mm)	35.7 in (906 mm)	WT

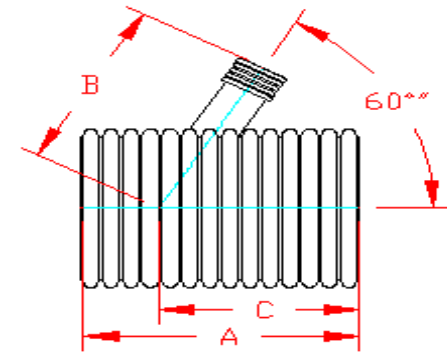

PLAIN END

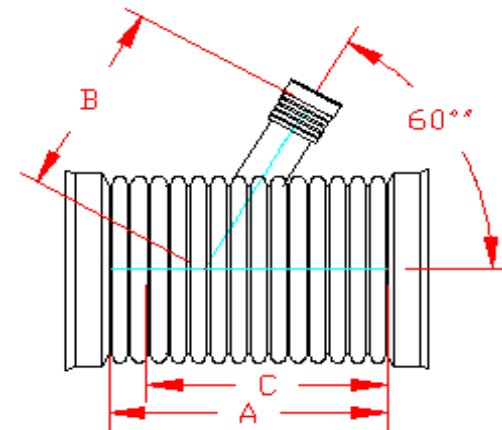

WT (INCLUDES 3 GASKETS)

* = PLAIN END
 ST = SOIL TIGHT
 WT = WATER TIGHT

NOTE: ALL FITTINGS DIMENSIONS ARE FOR REFERENCE ONLY

© 2023 Advanced Drainage Systems, Inc.



DRAWING #:	2375	
DRAWN BY:	JCB	04.20.06
APPROVED BY:	JCB	06.26.07
REVISIONS:	NJP	06.14.07